



Accessories Catalogue

Effective September 1, 2017

INTERNATIONAL



VOLUME 10

1 YEAR WARRANTY	2 YEAR WARRANTY	5 YEAR WARRANTY	3 YEAR COMPONENTS, 5 YEAR COMPRESSOR WARRANTY
-----------------	-----------------	-----------------	---

Accessories / Mining Accessories	Premium Underbody Protection	Monster Winch	IceCube Fridge / Freezer
Underbody Protection			

Ironman 4x4 warrants the original buyer, only when purchased new via authorised Ironman 4x4 resellers and distributors, from date of retail sale and cannot be transferred.

Product is warranted against defects in material or workmanship that cause the product to perform below the specified limits set by Ironman 4x4, to the extent that Ironman 4x4 will repair or replace any parts which are found to be defective.

It is at the discretion of Ironman 4x4 if a repair will be made or a replacement issued once the product has been inspected by an Ironman 4x4 representative and deemed to be a genuine warrantable claim.

All warranty claims must be submitted via original purchasing store or chain, unless otherwise arranged.

Proof of original purchase must be presented upon request.

Products may be required to be returned to Ironman 4x4 for assessment or repair. Ironman 4x4 is not responsible for postage or removal costs involved, but assistance may be considered at the discretion of Ironman 4x4 in the event of such a claim being verified.

The warranty does NOT apply where, 1) acts of neglect or misuse are evident, 2) product has been modified, 3) vehicles which are modified or not the recommended vehicle of use, 4) used in racing or competition conditions without the prior consent of Ironman 4x4, 5) used beyond the expectations of the original vehicle manufacturer.

Before installation of any product, please ensure you have received the correct parts for your application.

Ordering of the correct parts is the responsibility of the buyer. Return of a product in an unused condition will attract a 15% restock fee, where Ironman 4x4 is not at fault.

Return of used or soiled product, 1) outside warranty period, 2) without fault, will result in refusal of your claim and be returned at buyer's expense.

Damage to products through fitment error is not covered under warranty.

Our goods come with statutory guarantees that cannot be excluded under Australian Consumer Law. You are entitled to a replacement or refund for a major failure and for compensation for any other reasonably foreseeable loss or damage contingent on that failure. You are also entitled to have the goods repaired or replaced if they fail to be of acceptable quality even if the failure does not amount to a major failure

FREIGHT CONDITIONS:

Freight of all products is the buyer's responsibility.

Where Ironman 4x4 have arranged freight, costs involved will be invoiced to the buyer.

Ironman 4x4 is not responsible for damage or loss during freight.

FITTING:

All prices listed may be subject to fitting costs. The price of fitting is determined by the individual fitting agent.

Pricing subject to change without notice.

For further information please contact us on 1300 731 137 or email info@ironman4x4.com.

PRODUCT SPECIFICATIONS AND INFORMATION

Monster Winches	4
Bull Bars	4
Snorkels	7
Underbody Protection	8
Exhaust Systems	8

Roof Racks and Accessories	9
Driving Lights	10
Light Bars	11
Fridge / Freezers / Troubleshooting	12
Drawer Systems	13

Canopies	14
Rooftop Tent	15
Camping Swags	15

4WD AND TOURING GEAR

Recovery Equipment	16
Electric Winches and Accessories	16
Recovery Kits, Straps and Accessories	17
Tyre Accessories and Lifting Jacks	18
Compressors	18
Total Traction	19
Multi-Purpose Rear Wheel Bag	19
Seat Covers	19
First Aid	19
Driving Lights / Accessories	20
Driving Lights (LED, HID, Halogen)	20
Driving Light Accessories	21
Light Bars (LED)	22
Auto Electrical	23

Fridge / Freezers	24
Fridge / Freezers	25
Slides and Accessories	25
Camping	26
Rooftop Tent and Accessories	27
Awnings	27
Swags	27
Camping Accessories	28
Camping Chairs / Sleeping	28
Camp / Kitchen	29
Solar / Fishing	30
Toilets / Alice	31
Camp Lighting	32
Camping Tools	33

Roof Racks	34
Alloy Roof Racks	34
Steel Roof Racks	35
Accessories	34 / 35
Storage	36
Single / Twin Drawer Systems and Wing Kits	36
Rooftop Storage and Carry Bags	37
Maxi Cases and Ute Boxes	38
Aluminium and Metal Tool Boxes	39
General and Mining Accessories	40
Water Tanks	40
Mining	40
Apparel	41
Merchandise	42

VEHICLE ACCESSORIES

FORD	
Maverick	43
PX Ranger Mk II	44
PX Ranger	46
PJ, PK Ranger	48
Everest 2015+	49
HOLDEN	
RG Trailblazer	50
RG Colorado 11/2016+	51
RG Colorado 2012-10/2016	52
RG Colorado 7	53
RC Colorado	54
RA7 Rodeo	55
RA Rodeo	56
ISUZU	
D-Max 2/2017+	57
D-Max 6/2012-1/2017	58
D-Max 2007- 6/2012	59
MU-X 2014-2/2017	61
MU-X 3/2017+ (facelift)	61
JEEP	
WK2 Grand Cherokee	62
JK Wrangler	63
LAND ROVER	
Defender 2007-2016	64
Discovery Series 2, 3 and 4	65

LEXUS	
LX 570	94
LX 470	96
LX 450	97
MAZDA	
BT-50 2012+ (Includes 2016 facelift)	66
BT-50 11/2006 - 2012	68
MITSUBISHI	
Pajero Sport 11/2016+	69
NW Pajero	70
NM, NP, NS, NT Pajero	71
MQ Triton	72
MN Triton	73
ML Triton	74
NISSAN	
NP300 Navara	75
D40 Navara	76
D22 Navara	78
R51 Pathfinder	79
Y62 Patrol	81
Y61 GU Patrol Series 4+	82
Y61 GU Patrol Series 1-3	83
Y60 GQ Patrol	84
SUZUKI	
Grand Vitara	85
Jimny	86

TOYOTA	
FJ Cruiser	87
Hilux Revo 2015+	88
Hilux Vigo 2011-2015	89
Hilux Vigo 2005-2011	90
Hilux Tiger 1997-2004	91
Fortuner 2015+	92
Landcruiser 200 Series (facelift) 11/2015+	93
Landcruiser 200 Series 2/2012-10/2015	94
Landcruiser 200 Series 11/2007 -1/2012	94
Landcruiser 105 Series	95
Landcruiser 100 Series	96
Landcruiser 80 Series	97
Landcruiser 79 Series 2007-8/2016	98
Landcruiser 79 Series 9/2016+ Single Cab	98
Landcruiser 79 Series 11/2012+ (Dual Cab)	99
Landcruiser 78 Series (Troop Carrier)	100
Landcruiser 76 Series	101
Landcruiser 75, 78, 79 Series 1984-2007	102
Landcruiser 60 Series	103
Prado 150 Series 11/2009-10/2013	104
Prado 150 Series 11/2013+ (facelift)	104
Prado 120 Series	105
Prado 90, 95 Series	106
VOLKSWAGEN	
Amarok V6 11/2016+	107
Amarok 2011 to 10/2016	108

Spare Parts	109
--------------------	------------

Product Code Quick Reference Index	115
---	------------

Terms and Conditions	118
-----------------------------	------------

MONSTER WINCH

Part Number	Capacity	Description	Weight
WWB9500	9500lb	With Steel Cable and Wireless Plug in Controller	N.W 42kg (90lb)
WWB12000	12000lb	With Steel Cable and Wireless Plug in Controller	N.W 44kg (119lb)
WWB9500SR	9500lb	With Synthetic Rope and Wireless Plug in Controller	N.W 28kg (62lb)
WWB12000SR	12000lb	With Synthetic Rope and Wireless Plug in Controller	N.W 29kg (64lb)

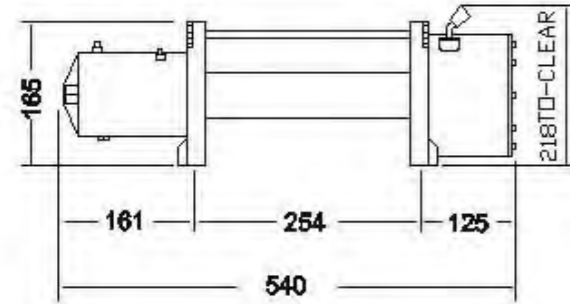

Side View

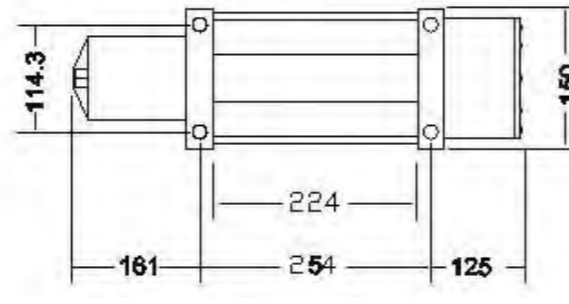

Bolting Pattern

BULL BARS

IMPORTANT: Ironman 4x4 bull bars conform to Australian Standards AS47861.1/2002



Commercial BBC

- ADR 69, 73 approved
- Air bag tested and certified
- Winch compatible
- Aerial mount
- Steel construction
- A-Frame triple loop design
- Tough polyurethane bumpers
- LED parker / indicator included



Commercial Deluxe BBCD

- ADR 69, 73 approved
- Air bag tested and certified
- Winch compatible
- Aerial mount
- Steel construction
- A-Frame triple loop design
- Tough polyurethane bumpers
- Fog lights (55W H3)
- LED parker / indicator included



Premium Commercial Deluxe BBP

- ADR 69, 73 approved
- Air bag tested and certified
- 60.3mm steel tube construction
- Winch compatible
- Aerial mount
- A-Frame triple loop design
- Tough polyurethane bumpers
- Fog lights (55W H3)
- LED parker / indicator included



Protector BBT

- ADR 69, 73 approved
- Air bag tested and certified
- Winch compatible
- Aerial mount
- Steel construction
- Stainless steel triple loop design
- Tough polyurethane bumpers
- Fog lights (55W H3)
- LED parker / indicator included



Polished Alloy BBA

- ADR 69, 73 approved
- Air bag tested and certified
- Winch compatible
- Aerial mount
- 5mm aluminium frame
- 5mm sub frame
- 35% lighter than steel
- A-Frame triple loop design
- Tough polyurethane bumpers
- LED parker / indicator included

Vehicle Make and Model	Commercial	Commercial Deluxe	Protector	Polished Alloy	Prem Comm Deluxe	Rear Step Tow Bars	Tow Bars	Side Steps	Side Steps and Rails	Page
Approximate Weight	86kg	86 kg	82kg	62kg	92kg	69kg	30kg	40kg	53kg	
Tube Thickness	51mm	51mm	51mm	51mm	60.3mm	51mm	N/A	51mm	51mm	
Ford Maverick 1988-1994	BBC010	BBCD010								43
Ford Ranger PX Mk II 2015+ WITH Adaptive Cruise Control		BBCD054	BBT054	BBA054		RTB038	TB038	SS054	SSR054	44
Ford Ranger PX Mk II 2015+ WITHOUT Adaptive Cruise Control		BBCD054	BBT054	BBA054		RTB038	TB038	SS054	SSR054	44
Ford Ranger PX Mk II 2015+ WITHOUT Adaptive Cruise Control With Sensor Provisions	BBC055	BBCD055				RTB038	TB038	SS054	SSR054	44
Ford Ranger PX 9/2011-2015	BBC038	BBCD038	BBT038	BBA038		RTB038	TB038	SS054	SSR054	46
Ford Ranger PJ / PK 2007+ ²	BBC014	BBCD014	BBT014					SS008	SSR002	48
Ford Everest 2015+ WITH Adaptive Cruise Control 2015+		BBCD054	BBT054	BBA054				SS055	SSR055	49
Ford Everest 2015+ WITHOUT Adaptive Cruise Control 2015+		BBCD054	BBT054	BBA054				SS055	SSR055	49
Ford Everest 2015+ WITHOUT Adaptive Cruise Control 2015+ With Sensor Provisions	BBC055	BBCD055						SS055	SSR055	49
Holden Trailblazer LT / LTZ 11/2017+	BBC057	BBCD057	BBT057					SS044	SSR044	50
Holden Colorado RG 11/2016+	BBC057	BBCD057	BBT057			RTB040	TB040	SS057	SSR057	51
Holden Colorado RG 2012-10/2016	BBC040	BBCD040	BBT040			RTB040	TB040	SS040	SSR040	52
Holden Colorado 7 RG 2012+	BBC044	BBCD044	BBT044					SS044	SSR044	53
Holden Colorado RC 2008-2012 ^{1 2}	BBC027	BBCD027	BBT027					SS001	SSR006	54
Holden Rodeo RA7 2007 - 2008	BBC020	BBCD020	BBT020					SS001	SSR006	55
Holden Rodeo RA 2002-2006 ²		BBCD003						SS001	SSR006	56
Isuzu D-MAX 2/2017+ (Will not fit narrow body)	BBC058	BBCD058	BBT058			RTB041	TB041	SS058	SSR058	57
Isuzu D-MAX 6/2012-2017	BBC041	BBCD041	BBT041			RTB041	TB041	SS041	SSR041	58
Isuzu D-MAX 2007-2012 ²	BBC020	BBCD020	BBT020					SS001	SSR006	59
Isuzu MU-X 2014-2/2017	BBC049	BBCD049	BBT049					SS044	SSR044	61
Isuzu MU-X 3/2017+		BBCD061						SS044	SSR044	61
Jeep Grand Cherokee WK2 2013+		BBCD052		BBA052						62
Jeep Wrangler JK 2007+		BBCD035								63
Land Rover Defender 2007-2016	BBC023									64
Mazda BT50 2012+ ²	BBC039	BBCD039	BBT039			RTB038	TB038	SS039	SSR039	66
Mazda BT50 11/2006-2012 ^{1 2}	BBC024	BBCD024	BBT024					SS009	SSR007	68
Mitsubishi Pajero Sport 11/2016+ (GLX +GLS only)		BBCD059	BBT059					SS059		69
Mitsubishi Pajero NW 2011-NX	BBC045	BBCD045	BBT045							70
Mitsubishi Triton MQ 2015+	BBC050	BBCD050	BBT050	BBA050		RTB050	TB050	SS050	SSR050	72
Mitsubishi Triton MN 2009-2015 ^{1 2}	BBC031	BBCD031	BBT031					SS031	SSR031	73
Mitsubishi Triton ML 2006-2009 ^{1 2}	BBC016	BBCD016	BBT016					SS004	SSR031	74
Nissan Navara NP300 2015+	BBC048	BBCD048	BBT048	BBA048		RTB048	TB048	SS048	SSR048	75
Nissan Navara D40 ² (Does not suit 2010+ STX - Spain Build)	BBC012	BBCD012	BBT012					SS007	SSR003	76
Nissan Navara D40 V6 2010+ STX ²	BBC042	BBCD042	BBT042					SS042	SSR042	76
Nissan Navara D22 2002+ ^{1 2}	BBC013	BBCD013	BBT013							78

NOTE: ¹ Suits flared guard model. ² Suits both 2WD and 4WD models

BULL BARS, REAR TOW BARS AND SIDE STEPS/RAILS

SNORKELS

TECHNICAL SPECIFICATIONS

Vehicle Make and Model	Commercial	Commercial Deluxe	Protector	Polished Alloy	Prem Comm Deluxe	Rear Step Tow Bars	Tow Bars	Side Steps	Side Steps and Rails	Page
	86kg 51mm	86 kg 51mm	82kg 51mm	62kg 51mm	92kg 60.3mm	69kg 51mm	30kg N/A	40kg 51mm	53kg 51mm	
Pathfinder R51 2005-2010	BBC012	BBCD012	BBT012							79
Nissan Pathfinder R51 2010+	BBC042	BBCD042	BBT042							79
Nissan Patrol Y62 2010+			BBT062							81
Nissan Patrol Y61 GU Series 4 2005+ ¹ (Coil Spring Only)	BBC011	BBCD011	BBT011		BBP011			SS012	SSR012 / SSRP011	82
Nissan Patrol Y61 GU Series 1-3 1998-2004 ¹ (Coil Spring Only)		BBCD009						SS012	SSR012	83
Nissan Patrol Y60 GQ 1987-1997 ¹ (Coil Spring Only)	BBC010	BBCD010								84
Suzuki Grand Vitara Diesel Manual 2012+	BBC046	BBCD046	BBT046							85
Suzuki Jimny		BBCD063								86
Toyota FJ Cruiser 2007+		BBCD037	BBT037							87
Toyota Hilux Revo 2015+	BBC051	BBCD051	BBT051	BBA051		RTB051	TB051	SS051	SSR051	88
Toyota Hilux Vigo 10/2011-2015 ¹	BBC033	BBCD033	BBT033					SS033	SSR033	89
Toyota Hilux Vigo 2005-2011 ¹	BBC002	BBCD002	BBT002					SS033	SSR033	90
Toyota Hilux Tiger 1997-2004 IFS ¹	BBC001	BBCD001						SS005		91
Toyota Fortuner 2015+		BBCD053	BBT053	BBA053				SS053	SSR053	92
Toyota Landcruiser 200 Series 11/2015+			BBT056	BBA056	BBP056			SS056	SSR056	93
Toyota Landcruiser 200 Series 11/2015+ VX Sahara			BBT056-VX	BBA056-VX	BBP056-VX			SS056	SSR056	93
Toyota Landcruiser 200 Series / Lexus LX570 11/2007-2/2012	BBC025		BBT025		BBP025					94
Toyota Landcruiser 200 Series / Lexus LX 570 2/2012-10/2015	BBC043		BBT043		BBP043					94
Toyota Landcruiser 105 Series 3/1998-2007	BBC005	BBCD005	BBT005					SS014	SSR014	95
Toyota Landcruiser 100 Series IFS / Lexus LX470 3/1998-2007	BBC006	BBCD006	BBT006							96
Toyota Landcruiser 80 Series / Lexus LX 450 ¹	BBC004	BBCD004	BBT004					SS013	SSR013	97
Toyota Landcruiser 79 Series (V8 TD) 2007-8/2016 ¹	BBC019E		BBT019E		BBP019E			SS016	SSR016 / SSRP016	98
Toyota Landcruiser 79 Series (V8 TD) Single Cab 9/2016+ ¹	BBC019SC		BBT019SC		BBP019SC			SS016SC	SSR016SC / SSRP016SC	98
Toyota Landcruiser 79 Series Dual Cab 11/2012+ ¹	BBC019E		BBT019E		BBP019E			SS019	SSR019 / SSRP019	99
Toyota Landcruiser 78 Series Troop Carrier 2007+ ¹	BBC019E		BBT019E		BBP019E					100
Toyota Landcruiser 76 Series 2007+ ¹	BBC019E		BBT019E		BBP019E			SS015	SSR015 / SSRP015	101
Toyota Landcruiser 75, 78, 79 Series 1984-2007	BBC018	BBCD018	BBT018							102
Toyota Prado 150 Series Facelift 10/2013+	BBC047	BBCD047	BBT047	BBA047				SS047	SSR047	104
Toyota Prado 150 Series 11/2009-10/2013	BBC029	BBCD029	BBT029					SS047	SSR047	104
Toyota Prado 120 Series 4/2003-2009 ¹	BBC008	BBCD008	BBT008					SS017	SSR004	105
Toyota Prado 90, 95 Series 1996-2002 ¹	BBC007	BBCD007	BBT007							106
Volkswagen Amarok V6 11/2016+		BBCD060						SS034	SSR034	107
Volkswagen Amarok 2011-10/2016	BBC034	BBCD034	BBT034					SS034	SSR034	108

SNORKELS

Vehicle Make	Model and Specifics	Part Number	Page
Ford Maverick	1988-1994 - (All models except 2.8L Diesel)	ISNORKEL011	43
Ford Ranger	PX XL 7/2011+ 2.2 and 3.2L Diesel	ISNORKEL034	44, 46
Ford Ranger	PX XLT 7/2011+ 2.2 and 3.2L Diesel	ISNORKEL034XLT	44, 46
Ford Ranger	PJ / PK 2006-2011+ - 3.0L TDi Diesel	ISNORKEL021	48
Holden Trailblazer	LT LTZ 2017+	ISNORKEL036	50
Holden Colorado	RG 11/2016+	ISNORKEL036	51
Holden Colorado / Colorado 7	2012-10/2016	ISNORKEL036	51, 52, 53
Holden Colorado	RC 2008-2012	ISNORKEL028	54
Holden Rodeo	RA7 LX and LT 2007-7/2008 - (Does not fit DX Model)	ISNORKEL022	55
Isuzu D-Max	2009-2012 - (Does not fit 4x2 SX Model)	ISNORKEL022	59
Mazda BT50	11/2006-2012 - 3.0L TDi Diesel	ISNORKEL024	68
Mitsubishi Triton	2006-2015	ISNORKEL020	73, 74
Nissan Navara	D40 2005+ (Does not suit 2010+ STX - Spain Build OR Single Cab)	ISNORKEL019	76
Nissan Pathfinder	R51 2005+	ISNORKEL019	79
Nissan Patrol	GU Series 4 2005+	ISNORKEL013	82
Nissan Patrol	GU Series 1, 2 and 3 1998-2004	ISNORKEL015	83
Nissan Patrol	GQ 1987-1997 - (All models except 2.8L Diesel)	ISNORKEL011	84
Toyota Hilux	Revo 2015+ - 2.8L Turbo Diesel	ISNORKEL051	88
Toyota Hilux	Vigo 2005-2015 - 3.0L TDi, 4.0L Petrol V6	ISNORKEL001	89, 90
Toyota Landcruiser	200 Series 2015+	ISNORKEL056	93
Toyota Landcruiser	200 Series 2007-2015	ISNORKEL010	94
Toyota Landcruiser / Lexus	105 and 100 Series / LX 470 1998-2007	ISNORKEL003	95, 96
Toyota Landcruiser / Lexus	80 Series / LX 450 1990-1998	ISNORKEL004	97
Toyota Landcruiser	79 Series 2007+	ISNORKEL023	98, 99
Toyota Landcruiser	78 Series Troop Carrier 2007+	ISNORKEL023	100
Toyota Landcruiser	76 Series 2007+	ISNORKEL023	101
Toyota Landcruiser	75, 78, 79 Series 1984-2007	ISNORKEL009	102
Toyota Prado	150 Series 2009+ 3L D4D TDi / 4L Petrol V6 and 2.8L D4D TDi	ISNORKEL035	104
Toyota Prado	120 Series 2003-2009 3L D4D TDi / 4L Petrol V6	ISNORKEL006	105
Toyota Prado	90 / 95 Series 1996-2002 3.4L Petrol V6	ISNORKEL005	106
Volkswagen Amarok	2011+	ISNORKEL037	107, 108

TECHNICAL SPECIFICATIONS

REFER TO VEHICLE LISTING PAGES FOR SPECIFIC MODEL COMPATIBILITY / SUITABILITY

REFER TO VEHICLE LISTING PAGES FOR SPECIFIC MODEL COMPATIBILITY / SUITABILITY

NOTE: ¹ Suits flared guard model. ² Suits both 2WD and 4WD models

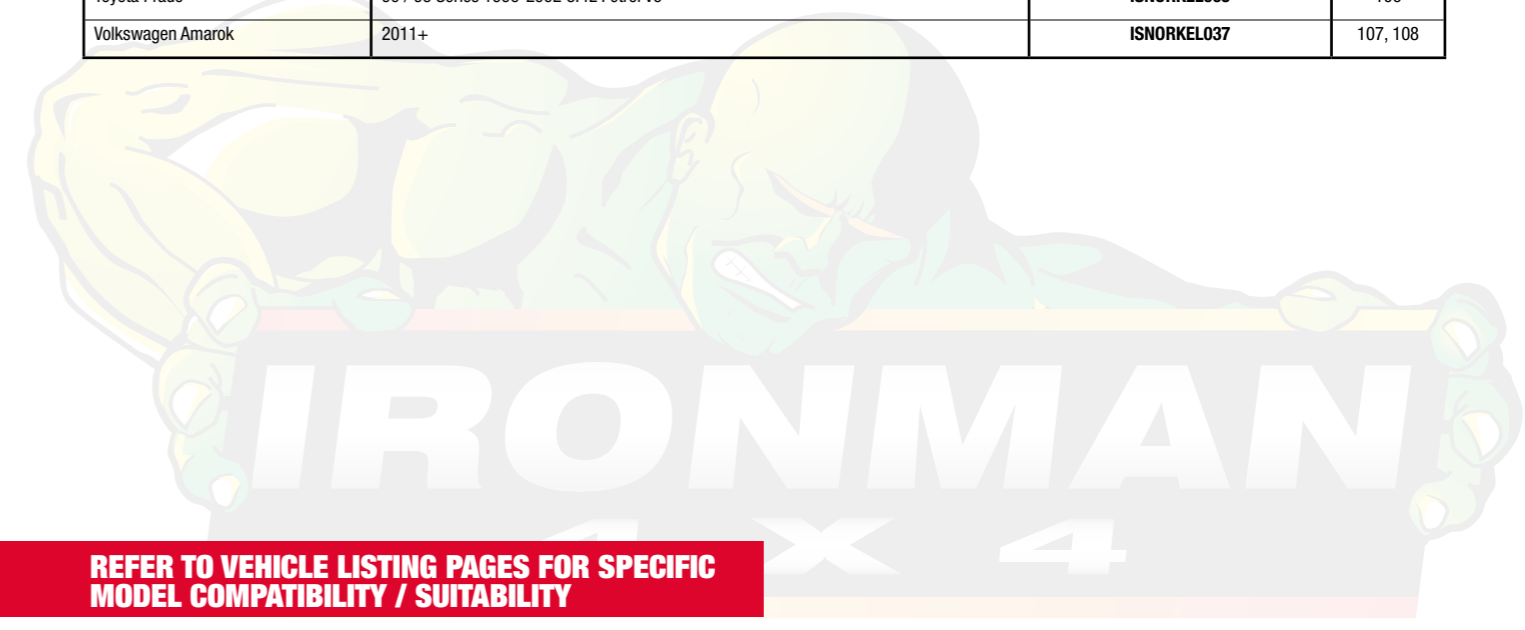

UNDERBODY PROTECTION

Vehicle Make	Model and Specifics	Standard Part No.	Premium Part No.	Page
Ford Ranger	PX 2011+ / PX Mk II 2015+	IUP014K / IUP014F	UBP054	44, 46
Ford Ranger	PJ / PK 2006-2011	IUP008K		48
Ford Everest	9/2015+	IUP014K / IUP014F	UBP054	49
Holden Colorado / Trailblazer	RG 11/2016+ / Trailblazer LT / LTZ 2017+		UBP057	50, 51
Holden Colorado	RG 2012-10/2016 / Colorado 7 RG 2012-2016		UBP041	52, 53
Holden Colorado	RC 2008-2012	IUP009K		54
Holden Rodeo	RA and RA7 2002-2008	IUP009K		55, 56
Isuzu D-Max / MU-X	2/2017+ / MU-X 2014+		UBP041	57, 61
Isuzu D-Max	2007-06/2012	IUP009K		59
Landrover Discovery	Series 2, 3 and 4	IUP016K		65
Mazda BT50	2012+	IUP014K / IUP014F	UBP054	66
Mazda BT50	2006-2012	IUP008K		68
Mitsubishi Pajero	2000-2011	IUP013K		70, 71
Mitsubishi Triton	MQ 2015+	IUP050K	UBP050	72
Mitsubishi Triton	ML 2006-2009	IUP010K / IUP010F		74
Nissan Navara	NP300 2015+		UBP048	75
Nissan Navara	D40 2005+ (Diesel only)	IUP007K / IUP007F		76
Nissan Navara	D22 2002+	IUP006K		78
Nissan Pathfinder	2005+	IUP007E		79
Nissan Patrol	GU Series 1, 2, 3 and 4 1998+ (3.0L and 4.8L only)	IUP015K		82, 83
Suzuki Grand Vitara	Diesel Manual 2012+	IUP011K		85
Toyota FJ Cruiser	2007+	IUP003K		87
Toyota Hilux / Fortuner	2015+		UBP051	88, 92
Toyota Hilux	Vigo 2005-2015	IUP001K		89, 90
Toyota Landcruiser	200 Series 2015+	IUP004E		93
Toyota Landcruiser	200 Series 2007-2015	IUP004K / IUP004F		94
Toyota Prado	150 Series 2009+	IUP003K / IUP003F		104
Toyota Prado	120 Series 2003-2009	IUP002K		105
Volkswagen Amarok	2011+	IUP012K		107, 108

BIG BORE EXHAUST SYSTEM

Vehicle Make	Model and Specifics	Motor	Part Number	Page
Ford Ranger	PX 2011+ - 3.2L	P5AT####	IEXHAUST007	44
Ford Ranger	PX 2011+ - 2.2L	P4AT####	IEXHAUST020	46
Ford Ranger	PJ / PK 2006-2011 - 3.0L TDi Diesel (Automatic)	WEAT	IEXHAUST014	48
Ford Ranger	PJ / PK 2006-2011 - 3.0L TDi Diesel (Manual)	WEAT	IEXHAUST015	48
Holden Colorado	2012-2016 - 2.8L Turbo Diesel	APL-G102#### 132kw	IEXHAUST017	52
Isuzu D-Max	2012-1/2017 - 3.0L Turbo Diesel	4JJ1TC - 130kw	IEXHAUST016	58
Mazda BT50	2012+ - 3.2L Diesel / 2.2L Diesel	P5AT#### / P4AT####	IEXHAUST008 / IEXHAUST020	66
Mazda BT50	2006-2012 - Diesel Only Automatic / Diesel Only Manual	WLAT / WLAT	IEXHAUST014 / IEXHAUST015	68
Mitsubishi Triton	2009-2015 - Automatic / Manual	4D56	IEXHAUST019	73
Nissan Navara	D40 550 1/2011+ - V6 Turbo Diesel	V9X	IEXHAUST012	76
Nissan Navara	D22 2002+ - 2.5L Diesel Only	YD25	IEXHAUST011	78
Nissan Patrol	GU Series 1, 2, 3 and 4 1998+ - 3.0L Turbo Diesel Wagon	ZD30	IEXHAUST006	82, 83
Toyota Hilux	Vigo 2005-2015 - 3.0L D4D TDi	1KD-FTV	IEXHAUST005	89, 90
Toyota Landcruiser	200 Series 2007-2015 - 4.5L Twin Turbo Diesel	1VD-FTV	IEXHAUST003	94
Toyota Landcruiser / Lexus	100 Series / LX470 1998-2007 - 4.2L Turbo Diesel	1-HD-FTE	IEXHAUST010	96
Toyota Landcruiser	79 Series (V8 TD) 2007+	1VD-FTV	IEXHAUST001	98
Toyota Landcruiser	79 Series Dual Cab 2012+	1VD-FTV	IEXHAUST013	99
Toyota Landcruiser	78 Series Troop Carrier 2007+	1VD-FTV	IEXHAUST009	100
Toyota Landcruiser	76 Series 2007+	1VD-FTV	IEXHAUST002	101
Toyota Prado	150 Series (3.0L D4D LWB) 2009+	1KD-FTV	IEXHAUST004	104
Toyota Prado	120 Series (3.0L D4D TDi 1KD-FTV Engine ONLY) 2003-2009	1KD-FTV	IEXHAUST004	105

ROOF RACKS

Part Number	Type	Description	Weight	Dimensions (mm)		
				L	W	H
STEEL						
IRRCAGE14	Cage Style	Steel Roof Rack	37kg	1400	1250	150
IRRCAGE18	Cage Style	Steel Roof Rack	46kg	1800	1250	150
IRRCAGE22	Cage Style	Steel Roof Rack	52kg	2200	1250	150
IRRTENT18	Rooftop Tent Compatible	Steel Roof Rack	37kg	1800	1250	150
IRRTENT22	Rooftop Tent Compatible	Steel Roof Rack	45kg	2200	1250	150
IRRTRADE18	Trade Style	Steel Roof Rack - Open End	42kg	1800	1250	150
IRRTRADE22	Trade Style	Steel Roof Rack - Open End	49kg	2200	1250	150
ALLOY						
IRRCAGE14-ALLOY	Cage Style	Alloy Roof Rack - Mesh Floor	17kg	1400	1250	150
IRRCAGE18-ALLOY	Cage Style	Alloy Roof Rack - Mesh Floor	22kg	1800	1250	150
IRRCAGE22-ALLOY	Cage Style	Alloy Roof Rack - Mesh Floor	27kg	2200	1250	150
IRROPEN14-ALLOY	Trade Style	Alloy Roof Rack - Mesh Floor, Open End	16kg	1400	1250	150
IRRTRADE18-ALLOY	Trade Style	Alloy Roof Rack - Mesh Floor, Open End	20kg	1800	1250	150
IRRTRADE22-ALLOY	Trade Style	Alloy Roof Rack - Mesh Floor, Open End	25kg	2200	1250	150

NOTE: Please refer to vehicle listings pages for specific model compatibility/suitability

MOUNTING KITS

Part Number	Feet	Description	Height
IRRFEET100	8	100mm Gutter Mount	100
IRRFEET125	8	125mm Gutter Mount	125
IRRFEET150	8	150mm Gutter Mount	150
IRRFEET210	8	210mm Gutter Mount	210
IRRFEETLC100	8	Landcruiser 100 / 105 Series Roof Mount	Adjustable
IRRFEETLC200	8	Landcruiser 200 Series Roof Mount	Adjustable
IRRFEET001	6	Holden Colorado 7	Fixed
IRRFEETPRADO150	2	Toyota Prado 150	Fixed
IRRFEETMUX	4	Isuzu MU-X - Replaces Roof Rails	Fixed

Roof Mount

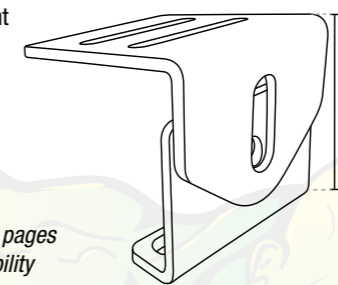

Gutter Mount

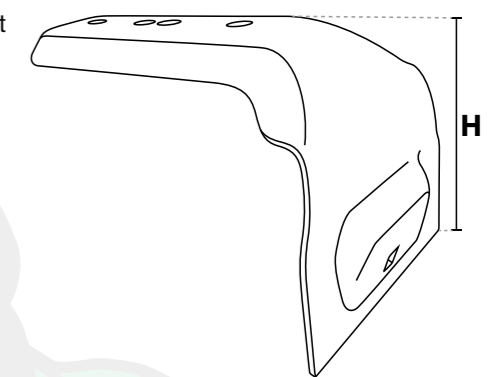

NOTE: Please refer to vehicle listings pages for specific model compatibility/suitability

UNIVERSAL ALLOY ROOF RAIL EXTRUSION

Part Number	Pieces	Description	Length
IRREXT945	2	Alloy Roof Rail Extrusion	945
IRREXT985	2	Alloy Roof Rail Extrusion	985
IRREXT1085	2	Alloy Roof Rail Extrusion	1085

REFER TO VEHICLE LISTING PAGES FOR SPECIFIC
MODEL COMPATIBILITY / SUITABILITY

DRIVING LIGHTS - HALOGEN AND HID

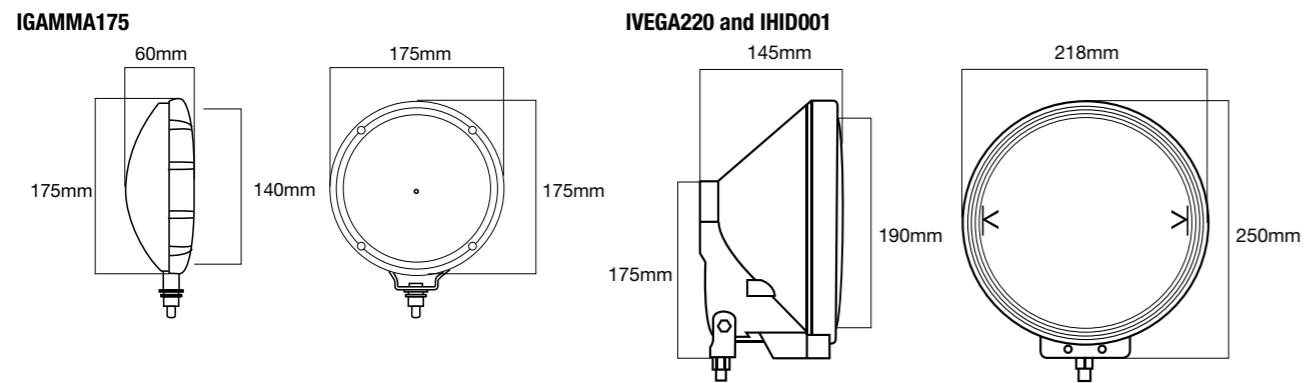

DRIVING LIGHTS - LED

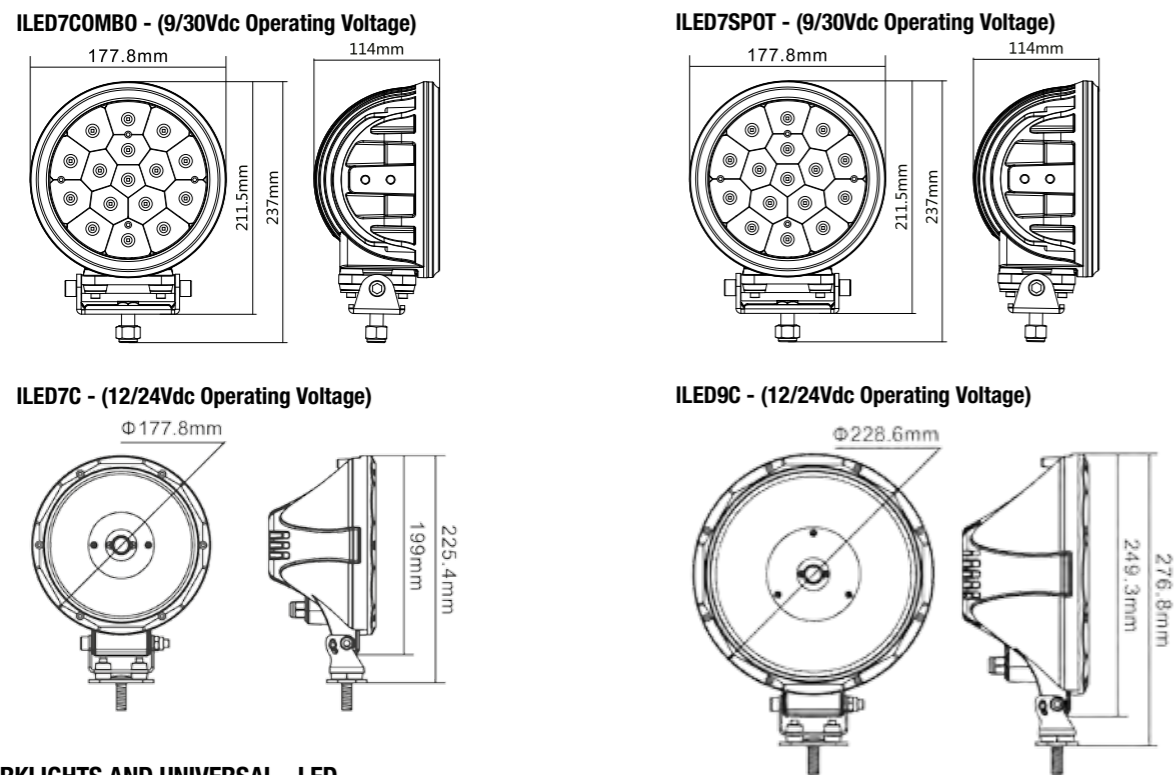

WORKLIGHTS AND UNIVERSAL - LED

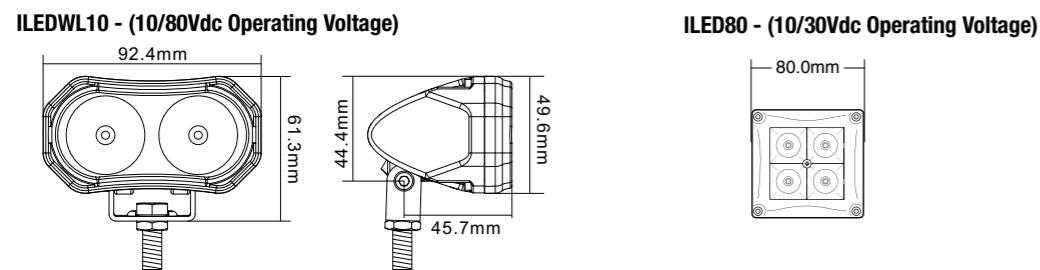

LIGHT BARS STRAIGHT - LED - (10/30Vdc Operating Voltage)

Side Bracket Dimensions

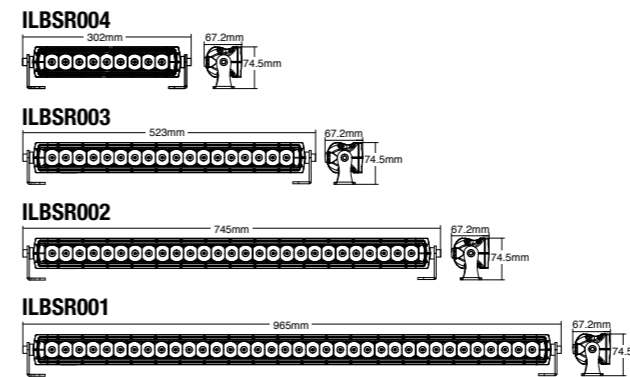

Bottom Bracket Dimensions

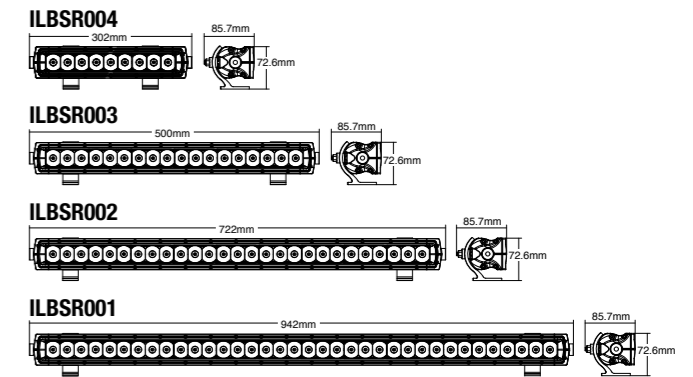

LIGHT BARS CURVED - LED - (10/30Vdc Operating Voltage)

Side Bracket Dimensions

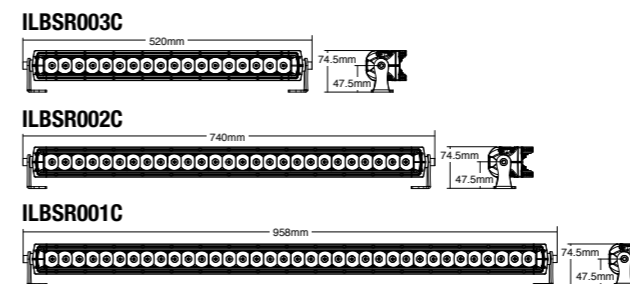

Bottom Bracket Dimensions

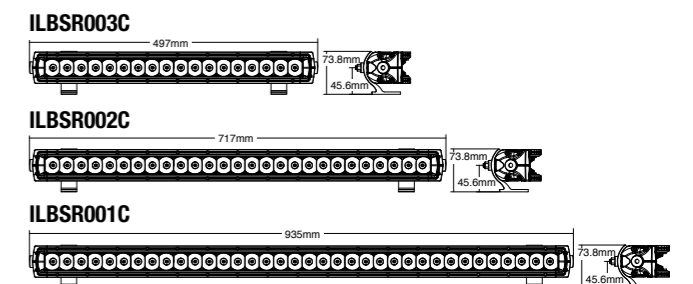

LIGHT BARS MODULAR - LED - (10/30Vdc Operating Voltage)

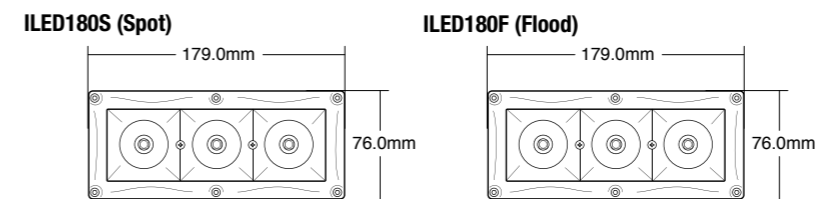

LIGHT BAR MODULAR COMBINATIONS

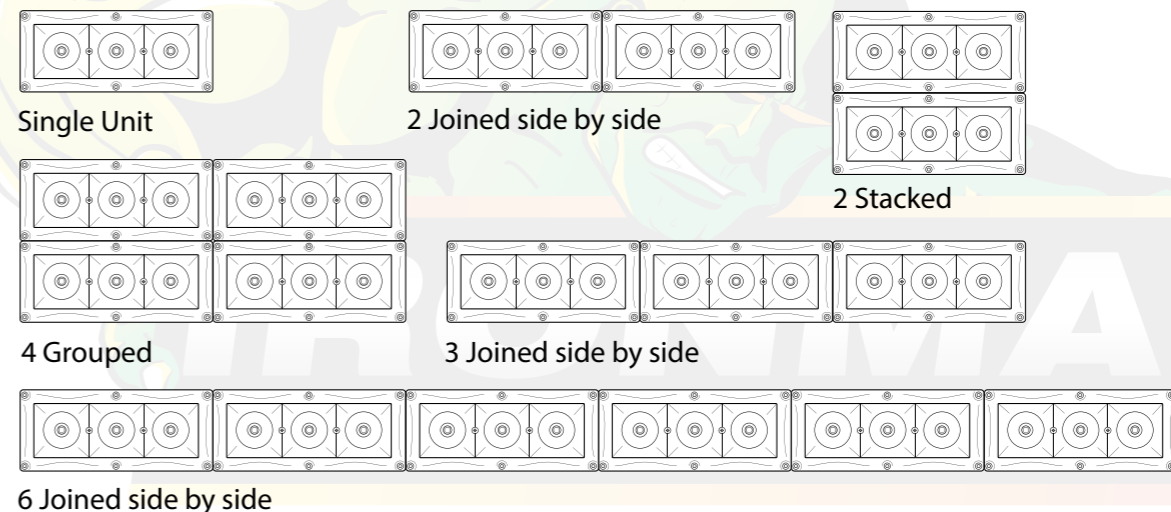

30L ICECUBE FRIDGE / FREEZER - IFRIDGE30SP

Overall Dimensions	585mm (L) x 380mm (H) x 350mm (W)
Weight	16kg (35lb)
Temperature Range / Regulation	+10 °C to -18 °C
Average Power Consumption	40 Watt

40L ICECUBE FRIDGE / FREEZER - IFRIDGE40SP

Overall Dimensions	585mm (L) x 490mm (H) x 350mm (W)
Weight	17kg (37lb)
Temperature Range / Regulation	+10 °C to -18 °C
Average Power Consumption	40 Watt

50L ICECUBE FRIDGE / FREEZER - IFRIDGE50SP

Overall Dimensions	585mm (L) x 530mm (H) x 350mm (W)
Weight	18.5kg (41lb)
Temperature Range / Regulation	+10 °C to -18 °C
Average Power Consumption	40 Watt

65L ICECUBE FRIDGE / FREEZER - IFRIDGE65SP

Overall Dimensions	785mm (L) x 490mm (H) x 470mm (W)
Weight	30kg (66lb)
Temperature Range / Regulation	+10 °C to -18 °C
Average Power Consumption	55 Watt

74L ICECUBE FRIDGE / FREEZER - IFRIDGE74SP

Overall Dimensions	785mm (L) x 490mm (H) x 470mm (W)
Weight	30kg (66lb)
Temperature Range / Regulation	+10 °C to -18 °C
Average Power Consumption	55 Watt

65L ICECUBE FRIDGE / FREEZER - COMPARTMENT COMBINATIONS

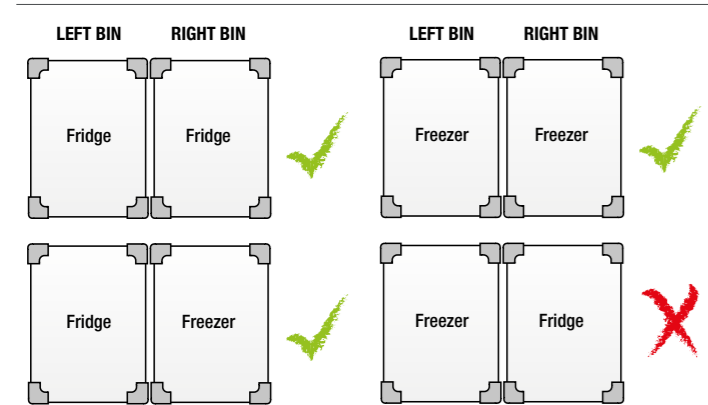

FRIDGE SLIDES

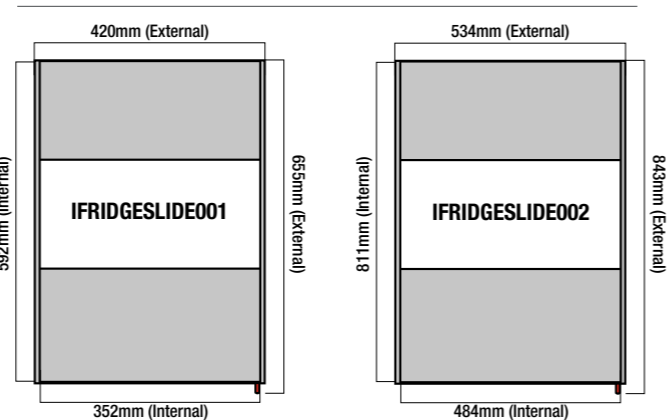

FRIDGE ERROR CODES LISTING AND TROUBLESHOOTING

Code	Error Type - Refer to User Manual for further information	Possible solution
E1	Battery protection stop auto cut-off (Battery too low or adjust protection setting)	Set battery protection to lower setting
E2	Fan fault (Check clearance around the fan)	Check for fan obstructions
E3	Compressor motor starter error (Low voltage power supply)	Check available voltage of 12/24V power supply, check all connections between battery and fridge, check condition of plug in lead
E4	Compressor motor running speed error (Overloaded motor cannot maintain 1850 times / min which is the lowest speed)	Return to place of purchase for assessment
E5	Compressor has over heated (Check clearance around the fan)	Check for sufficient air flow clearance around fridge
ER1	Control panel and temperature probe fault	Replacement of control panel or temperature probe

LOCKSAFE DRAWER SYSTEMS

900mm Drawer System	Weight	Length (mm)	Height (mm)	Width (mm)
TWIN - Cabinet specifications including drawers*	63kg	900	275	970
TWIN - Drawer specifications		840	206	425
SINGLE - Cabinet specifications including drawers*	34kg	900	275	570
SINGLE - Drawer specifications		840	206	425

1000mm Drawer System	Weight	Length (mm)	Height (mm)	Width (mm)
TWIN - Cabinet specifications including drawers*	76kg	1000	275	970
TWIN - Drawer specifications		940	206	450
SINGLE - Cabinet specifications including drawers*	39kg	1000	275	570
SINGLE - Drawer specifications		940	206	425

1300mm Drawer System	Weight	Length (mm)	Height (mm)	Width (mm)
TWIN - Cabinet specifications including drawers*	89kg	1300	275	970
TWIN - Drawer specifications		1240	206	425
SINGLE - Cabinet specifications including drawers*	46kg	1300	275	570
SINGLE - Drawer specifications		1240	206	425

* Top of timber to underside of fixing ribs

REFER TO VEHICLE LISTING PAGES FOR SPECIFIC MODEL COMPATIBILITY / SUITABILITY

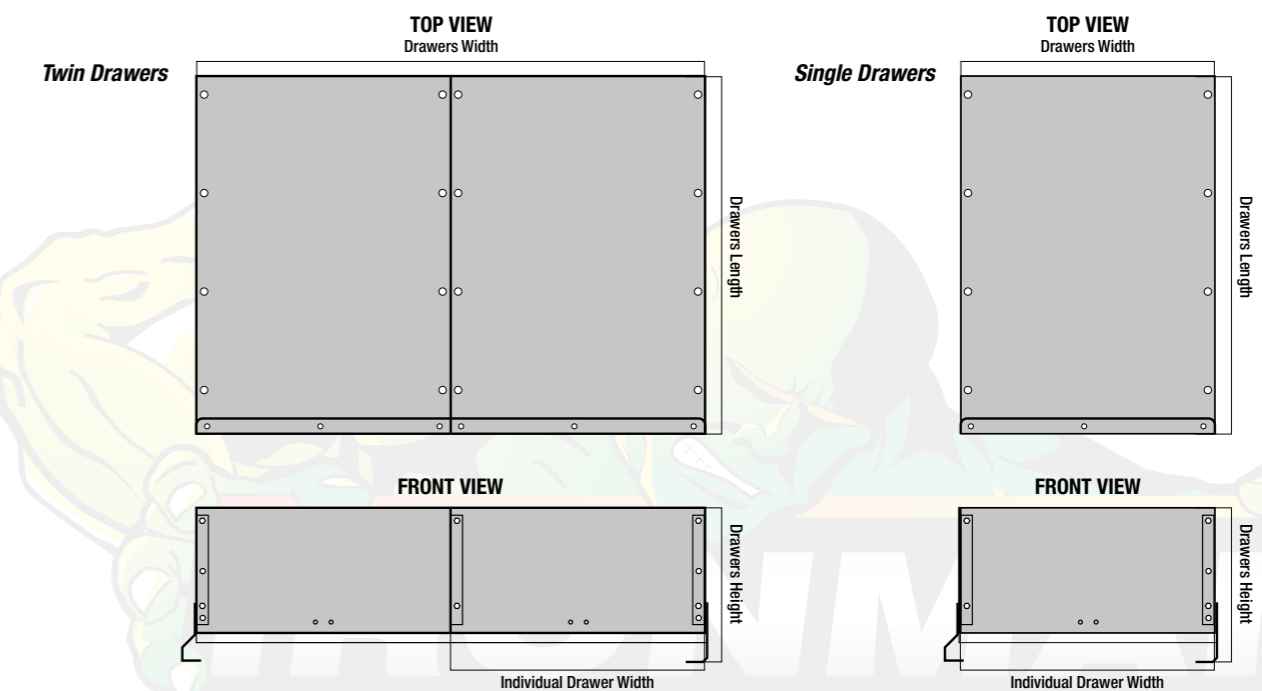

• For an absolute overall width of each cabinet, add 26mm to the widths given above. Basic cabinet height is 238mm with 12mm carpeted ply on top and 20mm high fixing ribs under giving an overall height of 270mm.

ABS PLASTIC CANOPIES GENERIC LISTING - WEIGHT 80KG

Vehicle Make	Model and Specifics	Part Number	Page
Ford Ranger	PX 2011-2015* / PX MkII 2015+*	CANOPY010	45, 47
Ford Ranger	PJ / PK 2006 to 2011*	CANOPY004	48
Holden Colorado	RG 11/2016+*	CANOPY019	51
Holden Colorado	RG 2012 to 10/2016*	CANOPY012	52
Holden Colorado / Rodeo	RC 7/2008 to 12/2012 / RA7 2007 to 7/2008 / RA 2002 to 2006	CANOPY006	54, 55, 56
Isuzu D-Max	2016+ *	CANOPY020	57
Isuzu D-Max	6/2012 to 1/2017*	CANOPY011	58
Isuzu D-Max	2007 to 6/2012	CANOPY006	59
Mazda BT50	2012+ (Includes 2016 Facelift)*	CANOPY010	67
Mazda BT50	J97M 11/2006 to 2012	CANOPY004	68
Mitsubishi Triton	MQ 2015+*	CANOPY014	72
Mitsubishi Triton	MN 2009 to 2015*	CANOPY008	73
Mitsubishi Triton	ML 2006 to 2009	CANOPY005	74
Nissan Navara	NP300 2015+*	CANOPY013	75
Nissan Navara	D40 2005+	CANOPY003	77
Nissan Navara	D22 2002+ *	CANOPY007	78
Toyota Hilux	Revo 2015+*	CANOPY015	88
Toyota Hilux	Vigo A Deck 3/2005 to 2015*	CANOPY001	89, 90
Toyota Hilux	Vigo J Deck 3/2005 to 2015*	CANOPY002	89, 90
Volkswagen Amarok	2011+	CANOPY009	107, 108

* Colour coded options available

SUPERLOCK KIT MUST BE USED TO SECURE CANOPIES TO VEHICLES FITTED WITH IRONMAN 4X4 TUB LINER

LUXURY ROOFTOP TENT - WEIGHT 62KG

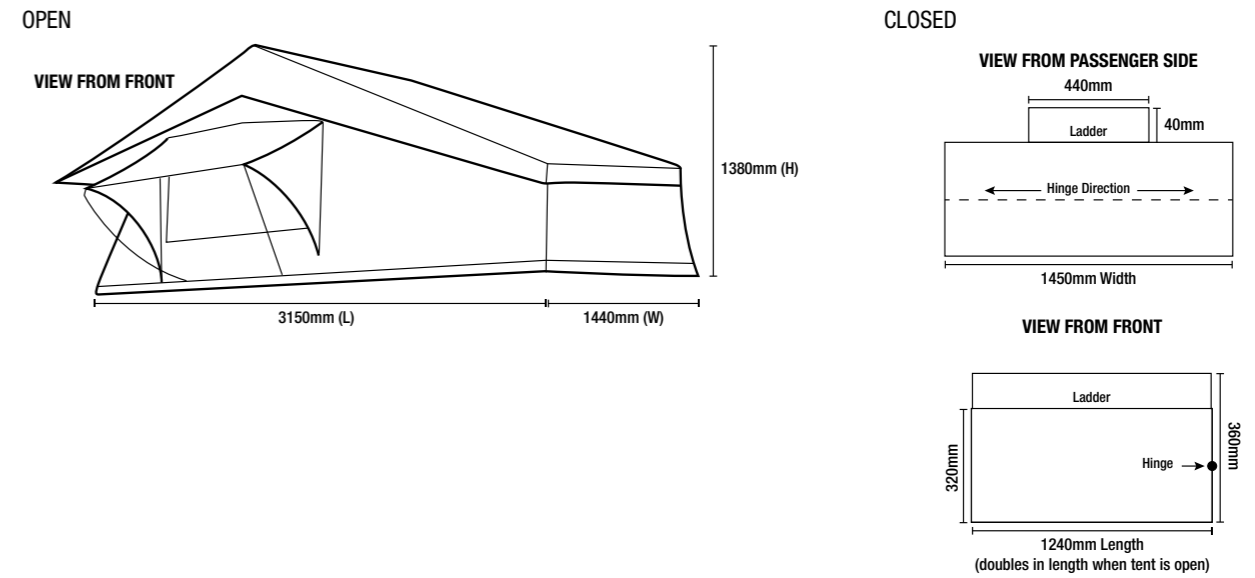

CAMPING SWAGS

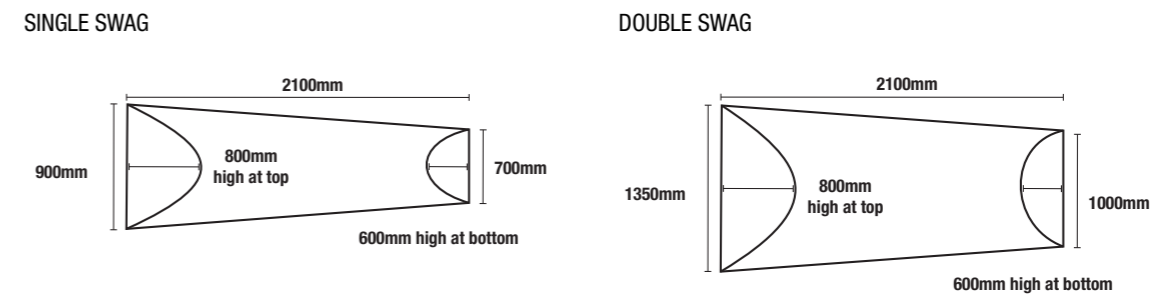

Accessory	Part No.
ELECTRIC WINCHES	
Monster Winch 9500lb - 12V	WWB9500
Monster Winch 9500lb - 12V (With Synthetic Rope)	WWB9500SR
Monster Winch 12000lb - 12V	WWB12000
Monster Winch 12000lb - 12V (With Synthetic Rope)	WWB12000SR
WINCH ACCESSORIES	
Winch Damper Blanket	WINCH BLANKET
Synthetic Winch Rope - 9.5mm x 27m (8100kg)	WWWROPE001
Alloy Hawse Fairlead	WWWHAWSE

**TECHNICAL DIMENSIONS AND SPECIFICATIONS
SEE PAGE 4**



MONSTER WINCH - WITH SYNTHETIC ROPE



MONSTER WINCH - WITH STEEL CABLE



ALLOY HAWSE



SYNTHETIC ROPE



WINCH DAMPER BLANKET

Accessory	Part No.
KITS / STRAPS AND ACCESSORIES	
Large Recovery Kit	IRECKIT001
Small Recovery Kit	IRECKIT002
Snatch Strap - 8000kg (9m x 75mm)	ISNATCH003
Snatch Strap - 11000kg (9m x 100mm)	ISNATCH004
Winch Extension Strap - 4500kg (20m x 50mm)	IWINCHEXT
Tree Trunk Protector - 12000kg (3m x 75mm)	ITREE
Heavy Duty Drag Chain (5m x 8mm)	IDRAG
Snatch Block - 8000kg Rating	IBLOCK
Recovery Hitch - 4.75t Rating (With Bow Shackle)	IHOOK BOW
Bow Shackle - 4.75t Rating	IBOW
Universal Recovery Hook - 4500kg Rating	ITOW
Leather Recovery Gloves	IGLOVES
Large Recovery / Accessory Bag	IRECKIT001 BAG
Small Recovery / Accessory Bag	IRECKIT002 BAG

LARGE RECOVERY KIT

SMALL RECOVERY KIT



8000KG SNATCH STRAP

11000KG SNATCH STRAP

SNATCH BLOCK

TREE TRUNK PROTECTOR

WINCH EXTENSION STRAP

DRAG CHAIN

UNIVERSAL RECOVERY HOOK

RECOVERY HITCH (WITH BOW SHACKLE)

BOW SHACKLE

HEAVY DUTY GLOVES



Accessory	Part No.
COMPRESSORS	
Flomax Air Compressor - 12V (72L/min)	ICOMPRESSOR001
Flomax Pro Air Compressor - 12V (160L/min)	ICOMPRESSOR002
TYRE ACCESSORIES	
Speedy Deflator	ISPEEDY
Tyre Repair Kit	ITYRE001
Tyre Repair Cord (Refill 25pc)	ITYRE002
Tyre Gauge	ITYRE003
LIFTING JACKS	
4WD Lift Jack - 48" (Inc. Cover)	IHIGHLIFT001
4WD Lift Jack - 60" (Inc. Cover)	IHIGHLIFT002
Bumper Lift Kit	IHIGHLIFT003
Tyre Lift Kit	IHIGHLIFT004



TYRE REPAIR KIT



FLOMAX



FLOMAX PRO



TYRE LIFT KIT



BUMPER LIFT KIT



SPEEDY DEFLATOR



TYRE GAUGE



4WD LIFT JACK

Accessory	Part No.
TOTAL TRACTION (BY TREDS)	
Recovery Tracks	ITREDS1100
MULTI-PURPOSE REAR WHEEL BAG	
Rear Wheel Bag	IRWB001
SEAT COVERS	
Universal Slip-On Seat Cover	ISEAT COVER
AIRBAG COMPATIBLE CANVAS SEAT COVERS	
Vehicle Specific Fitted Seat Cover - Front	See Vehicle Listing
Vehicle Specific Fitted Seat Cover - Rear	See Vehicle Listing
FIRST AID	
First Aid Kit (32 piece Kit)	IFIRSTAID001

TOTAL TRACTION



PLASTIC CASE FIRST AID KIT



MULTI-PURPOSE REAR WHEEL CARRIER BAG



UNIVERSAL SEAT COVER



CANVAS SEAT COVERS

Accessory

Part No.

LED DRIVING LIGHTS

- Comet 30W 7" LED - Driving Light (Each)
- Comet 42W 9" LED - Driving Light (Each)
- Blast 48W 7" Combo LED - Driving Light (Each)
- Blast 48W 7" Spot LED - Driving Light (Each)

- ILED7C
- ILED9C
- ILED7COMBO
- ILED7SPOT

LED



7" COMET

9" COMET



7" BLAST COMBO

7" BLAST SPOT

**TECHNICAL DIMENSIONS AND SPECIFICATIONS
SEE PAGE 10**

HALOGEN AND HID DRIVING LIGHTS

- Gamma 100W Halogen 7" - H3 Driving Light (Pair)*
- Vega 100W Halogen 9" - H1 Driving Light (Each)
- Supernova 35W HID 9" - H11 Driving Light (Each)
- *Kit includes 1x Flood Light and 1x Spot Light.

- IGAMMA175
- IVEGA220
- IHID001



HALOGEN

**GAMMA 175
FLOOD / SPOT**

VEGA 220



HID

SUPERNOVA

Accessory

Part No.

LED LIGHT COVERS

- 7" Blast Blue Light Cover
- 7" Blast Black Light Cover
- 7" Blast Amber Light Cover
- 7" Blast Clear Light Cover
- 7" Comet Blue Light Cover
- 7" Comet Black Light Cover
- 7" Comet Amber Light Cover
- 7" Comet Clear Light Cover
- 9" Comet Blue Light Cover
- 9" Comet Black Light Cover
- 9" Comet Amber Light Cover
- 9" Comet Clear Light Cover

- ILCB7BLUE
- ILCB7BLACK
- ILCB7AMBER
- ILCB7CLEAR
- ILC7BLUE
- ILC7BLACK
- ILC7AMBER
- ILC7CLEAR
- ILC9BLUE
- ILC9BLACK
- ILC9AMBER
- ILC9CLEAR



AMBER



BLACK



BLUE



CLEAR

**IRONMAN
4 X 4**

IceCube

COMPRESSOR FRIDGE & FREEZER

65L DUAL COMPARTMENT
AND DUAL CONTROL



SECOP BD50F COMPRESSOR
- German engineered
- Low energy consumption
- Electronically controlled



30L
CAPACITY

40L
CAPACITY

50L
CAPACITY

65L
CAPACITY

74L
CAPACITY

Accessory

Part No.

ICECUBE FRIDGE / FREEZERS

- IceCube Fridge / Freezer 30L
- IceCube Fridge / Freezer 40L
- IceCube Fridge / Freezer 50L
- IceCube Fridge / Freezer 65L - Dual Compartment / Dual Control
- IceCube Fridge / Freezer 74L - Large Capacity

- IFRIDGE30
- IFRIDGE40
- IFRIDGE50
- IFRIDGE65
- IFRIDGE74

FRIDGE / FREEZER SLIDES

- Fridge Slide - 30L, 40L, 50L (Inc. 4 x Straps)
- Fridge Slide - 65L, 74L (Inc. 4 x Straps)

- IFRIDGESLIDE001
- IFRIDGESLIDE002

FRIDGE / FREEZER ACCESSORIES (BAGS SOLD SEPARATELY)

- 30L Fridge Bag
- 40L Fridge Bag
- 50L Fridge Bag
- 65L / 74L Fridge Bag
- Fridge Straps
- Wireless LCD Fridge Thermometer
- Fridge Stand

- IFRIDGE30 BAG
- IFRIDGE40 BAG
- IFRIDGE50 BAG
- IFRIDGE 65 74 BAG
- IFRIDGE STRAPS
- IWFT001
- IFRIDGESTAND001

**TECHNICAL DIMENSIONS, SPECIFICATIONS
AND FRIDGE TROUBLESHOOTING - SEE PAGE 12**



30L, 40L, 50L FRIDGE SLIDE



65L, 74L FRIDGE SLIDE



WIRELESS LCD
FRIDGE THERMOMETER



FRIDGE / FREEZER STAND



FRIDGE CARRY BAG

4WD AND TOURING GEAR

Prices do not include freight or fitting. Prices are subject to change without notice. Colours and styles may vary to those displayed.

LUXURY ROOFTOP TENT



ROOFTOP TENT HANGING BAG



ANNEX WITH ANNEX EXTENSION KIT



ROOM ENCLOSURE



FLY SCREEN NETTING



LED AWNING

Accessory

Part No.

ROOFTOP TENT AND ACCESSORIES

- Rooftop Tent (Only)
 - Rooftop Tent - Annex (Only)
 - Extension Kit - Ladder (500mm)*
 - Extension Kit - Annex (Room 200mm)*
 - Rooftop Tent Hanging Bag
- * Required for tent bases sitting above 1.8m from ground.

- IROOFTENT TENT
- IROOFTENT ANNEX
- IROOFTENT002
- IROOFTENT003
- ITENTBAG001

INSTANT AWNING WITH INTEGRATED LED LIGHT STRIP

- Instant Awning 1.4m (L) x 2.5m (Out) (Inc. Brackets)
- Instant Awning 2m (L) x 2.5m (Out) (Inc. Brackets)
- Instant Awning 2.5m (L) x 2.5m (Out) (Inc. Brackets)
- Room Enclosure (Suits 1.4m x 2.5m IAWNING1.4M)
- Room Enclosure (Suits 2m x 2.5m IAWNING2M)
- Room Enclosure (Suits 2.5m x 2.5m IAWNING2.5M)
- Fly Screen Netting (Suits 1.4m x 2.5m IAWNING1.4M)
- Fly Screen Netting (Suits 2m x 2.5m IAWNING2M)
- Fly Screen Netting (Suits 2.5m x 2.5m IAWNING2.5M)

- IAWNING1.4M
- IAWNING2M
- IAWNING2.5M
- IAWNING004 ROOM
- IAWNING001 ROOM
- IAWNING005 ROOM
- IAWNING004 NET
- IAWNING001 NET
- IAWNING005 NET

ROOFTOP TENT AND CAMPING SWAG DIMENSIONS - SEE PAGE 14

SWAGS

- Single Swag
 - Double Swag
- ISWAG001
 - ISWAG002



CAMPING SWAGS

Accessory

Part No.

CAMP CHAIRS / SLEEPING

- Deluxe Hard Arm Camp Chair (150kg Rated)
- Deluxe Soft Arm Camp Chair (150kg Rated)
- Deluxe Lounge Camp Chair (150kg Rated)
- Mid Size Low Back Camp Chair (130kg Rated)
- Quick-Fold Camp Stretcher (150kg Rated)
- 5° Swag Bag Sleeping Bag

- ICHAIRHA004
- ICHAIRSA005
- ICHAIRL003
- ICHAIRMS
- IQFS001
- ISWAGBAG

**DELUXE HARD
ARM CHAIR**



**DELUXE SOFT
ARM CHAIR**



**DELUXE
LOUNGE CHAIR**



**MID SIZE LOW
BACK CHAIR**



**QUICK-FOLD
STRETCHER**



Accessory

Part No.

CAMP / KITCHEN

- Quick-Fold Table (50kg Rated)
- Picnic Set (43 Piece Set)
- Collapsible Silicone Kettle - Food Grade (1.5L)
- Collapsible Silicone Bucket - Food Grade (10L)
- Collapsible Silicone Tub - Food Grade (9L)
- Silicone Ice Cube Tray - Food Grade (32 cube)
- Quick-Fold Camping Steps (180kg Rated)
- 50L Cargo Bag
- 65L Explorer Duffle Bag

- ITABLE001
- IPICNICSET001
- IKETTLE001
- IBUCKET001
- IBUCKET002
- IICETRAY001
- IQFSTEP
- ICARGOBAG001
- IDUFBAG001

QUICK-FOLD TABLE



**SILICONE
PRODUCT RANGE**



**QUICK-FOLD
CAMPING STEPS**



PICNIC SET



**SWAG BAG
SLEEPING BAG**



65L DUFFLE BAG



50L CARGO BAG



Accessory

Part No.

CAMPING POWER

6 Panel Solar Mat Kit
44Ah Portable Power Pack

ISOLARMAT
IPOWER



SOLAR MAT KIT

PORTABLE POWER PACK

MULTIPLE CHARGING
OPTIONS: INCLUDING
VIA SOLAR PANEL
(Solar panel not included)

FISHING

Travel Master Multi-Rod (Makes up to 36 rod combinations)
Travel Master Multi-Reel (Inc. 3 pre-lined spools)

IFISHING001
IFISHING002



TRAVEL MASTER MULTI-ROD

TRAVEL MASTER MULTI-REEL
INCLUDES 3 PRE-LINED SPOOLS

Accessory

Part No.

CAMPING GEAR

Foldable Bush Toilet (200kg Rated)
Bush Toilet Replacement Biodegradable Bags (10 per Pack)
12L Ezy-Go Flushing Toilet
20L Ezy-Go Flushing Toilet
Ezy-Go Flush Aid Part A & B (Sold Together as 2 Part Kit)
Rechargeable Outdoor Camp Shower (Incl. Carry Bag)
Eco Pressure Shower (Incl. Carry Bag)
500ml Gritty Hand Wash (Box of 6 Only)
500ml Gritty Hand Wash (RRP Only)

IBUSHTOILET
IBTBAGS
ITOILET12
ITOILET20
ITOILETA+B
ISHOWER001
ISHOWER002
IHCLEANBOX
IHCLEAN



FOLDABLE
BUSH TOILET

12 LITRE
FLUSHABLE
TOILET

20 LITRE
FLUSHABLE
TOILET

BUSH TOILET
REPLACEMENT
BAGS

EZY-GO FLUSH
AID PART A+B

GRITTY
HAND WASH

ECO PRESSURE
SHOWER

RECHARGEABLE
CAMP SHOWER

Accessory

Part No.

LIGHTING

- LED Lantern
- Mini LED Lantern
- LED Lantern / Torch
- LED Worklight Combo
- LED Tent Light / Fan
- LED Tent Light
- LED Sensor Headlamp
- LED Light Strip (Incl. Switch)
- LED Dimmer
- Cordless Ultralight (Incl. 12V /240V Charger)

- ILANTERN003
- ILANTERN002
- ILANTERN001
- ILEDWLC
- ITENTFAN001
- ITENTLIGHT002
- IHEADLAMP002
- ILEDSTRIP
- ILEDDIMMER
- ITORCHLED001



LED LANTERN



MINI LED LANTERN



MINI LED LANTERN



LED WORKLIGHT COMBO



LED TENT LIGHT / FAN



LED TENT LIGHT



CORDLESS ULTRALIGHT



LED LIGHT STRIP

LED SENSOR HEADLAMP



Accessory

Part No.

CAMPING TOOLS

- 2.0Kg (4.4lb) Axe Splitter
- 0.7Kg (1.5lb) Axe
- Tent Peg Mallet
- 3 Piece Shovel (Incl. Carry Bag)
- Quick Grip Rubber Mounting Clamp Kit (8 Piece)

- IAXE001
- IAXE002
- IMALLET
- ISHOVEL001
- IQUICKGRIP001



0.7KG AXE



2.0KG AXE / SPLITTER



TENT PEG MALLET



3 PIECE SHOVEL



QUICK GRIP RUBBER MOUNTING CLAMP KIT



ALLOY ROOF RACKS / EXTRUSION RAILS

STEEL ROOF RACKS / MOUNT KITS

Accessory

Part No.

ALLOY ROOF RACKS - POWDERCOATED METALLIC GREY, MESH FLOOR

- Cage Style - 1.4m x 1.25m
- Cage Style - 1.8m x 1.25m
- Cage Style - 2.2m x 1.25m
- Trade Style - 1.4m x 1.25m (*Open end*)
- Trade Style - 1.8m x 1.25m (*Open end*)
- Trade Style - 2.2m x 1.25m (*Open end*)
- Crossbar

- IRRCAGE14-ALLOY
- IRRCAGE18-ALLOY
- IRRCAGE22-ALLOY
- IRROPEN14-ALLOY
- IRRTRADE18-ALLOY
- IRRTRADE22-ALLOY
- IRRCROSSBAR001

REFER TO VEHICLE LISTING PAGES FOR SPECIFIC MODEL COMPATIBILITY / SUITABILITY

TRADE STYLE



ALLOY RACKS

CAGE STYLE



UNIVERSAL ALLOY ROOF RAIL EXTRUSION - Sold Separately

- Alloy Extrusion - 945mm (2 Pieces - Inc. mounting hardware)
- Alloy Extrusion - 985mm (2 Pieces - Inc. mounting hardware)
- Alloy Extrusion - 1085mm (2 Pieces - Inc. mounting hardware)

- IRREXT945
- IRREXT985
- IRREXT1085



EXTRUSIONS



GUTTER MOUNT FEET



CHANNEL MOUNT FEET

Accessory

Part No.

STEEL ROOF RACKS - POWDERCOATED BLACK, MESH FLOOR

- Cage Style - 1.4m x 1.25m
- Cage Style - 1.8m x 1.25m
- Cage Style - 2.2m x 1.25m
- Rooftop Tent Compatible - 1.8m x 1.25m
- Rooftop Tent Compatible - 2.2m x 1.25m
- Trade Style - 1.8m x 1.25m (*Open end*)
- Trade Style - 2.2m x 1.25m (*Open end*)

- IRRCAGE14
- IRRCAGE18
- IRRCAGE22
- IRR TENT18
- IRR TENT22
- IRRTRADE18
- IRRTRADE22

REFER TO VEHICLE LISTING PAGES FOR SPECIFIC MODEL COMPATIBILITY / SUITABILITY

TRADE STYLE



STEEL RACKS

CAGE STYLE



ROOFTOP TENT



ROOF RACK MOUNTING KITS - Sold Separately

- Gutter Mount Feet - 100mm (8 Feet)
- Gutter Mount Feet - 125mm (8 Feet)
- Gutter Mount Feet - 150mm (8 Feet)
- Gutter Mount Feet - 210mm (8 Feet)
- Holden Colorado 7 Mount Feet (6 Feet)
- Toyota Landcruiser 100/105 Mount Feet (8 Feet)
- Toyota Landcruiser 200 Mount Feet (8 Feet)
- Isuzu MU-X Mount Feet (6 Feet) - Fits factory fitted roof bars only
- Toyota Prado 150 Mount Feet (2 Feet)
- Wheel Clamp

- IRRFEE100
- IRRFEE125
- IRRFEE150
- IRRFEE210
- IRRFEE001
- IRRFEE1C100
- IRRFEE1C200
- IRRFEE1MUX
- IRRFEE1PRADO150
- IRRWHEELCLAMP

TECHNICAL DIMENSIONS AND SPECIFICATIONS SEE PAGE 9
REFER TO VEHICLE MANUFACTURER FOR SPECIFIC ROOF LOAD CARRYING CAPACITY

4WD AND TOURING GEAR

4WD AND TOURING GEAR

Accessory	Part No.
LOCKSAFE SINGLE DRAWERS	
Single Drawer - 900mm	ISD900
Single Drawer - 1000mm	ISD1000
Single Drawer - 1300mm	ISD1300
LOCKSAFE TWIN DRAWERS	
Twin Drawers - 900mm	ITD900
Twin Drawers - 1000mm	ITD1000
Twin Drawers - 1300mm	ITD1300
WING KITS*	
Left and Right Pair - 900mm	Vehicle Specific
Left and Right Pair - 1000mm	Vehicle Specific
Left and Right Pair - 1300mm	Vehicle Specific

**TECHNICAL DIMENSIONS AND SPECIFICATIONS SEE PAGE 13
REFER TO VEHICLE LISTING PAGES FOR SPECIFIC MODEL COMPATIBILITY / SUITABILITY**

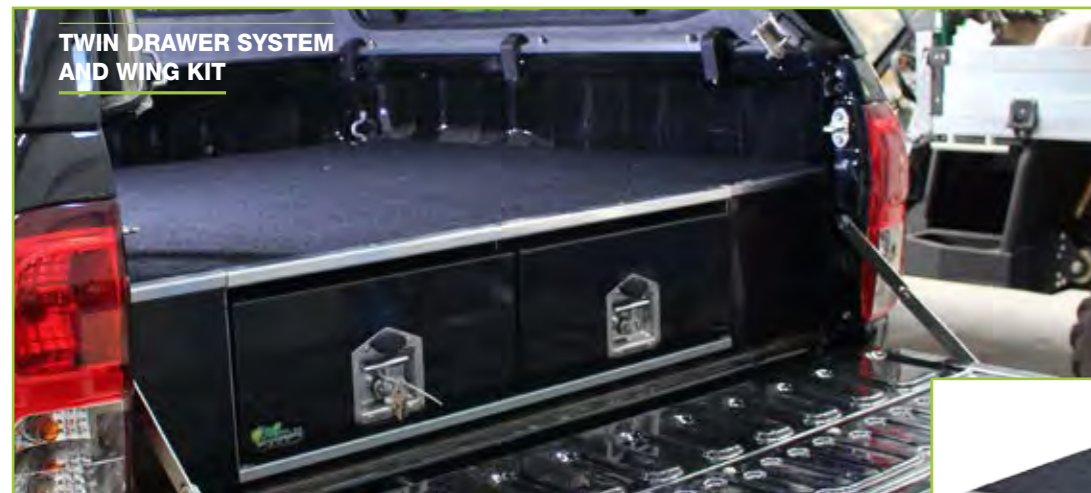

*Designed to suit factory tubs, will not suit tub liner without modification



Accessory	Part No.
CARRY AND UTILITY STORAGE BAGS - L x W x D	
200L Weatherproof Rooftop Cargo Storage Bag - 1400 x 500 x 300mm	IRLB200
250L Weatherproof Rooftop Cargo Storage Bag - 1100 x 800 x 300mm	IRLB250
350L Weatherproof Rooftop Cargo Storage Bag - 1200 x 960 x 300mm	IRLB350
500L Weatherproof Rooftop Cargo Storage Bag - 1500 x 1100 x 300mm	IRLB500
600L Weatherproof Rooftop Cargo Storage Bag - 1800 x 1100 x 300mm	IRLB600
50L Cargo Bag	ICARGOBAG001
65L Explorer Duffle Bag	IDUFBAG001
Roof Top Tent Hanging Bag	ITENTBAG001

200L ROOFTOP BAG



250L ROOFTOP BAG



350L ROOFTOP BAG



500L ROOFTOP BAG



600L ROOFTOP BAG



50L CARGO BAG



ROOFTOP TENT HANGING BAG



65L DUFFLE BAG



Accessory

Part No.

MAXI CASES - L x D x H

- 48L - 410 x 410 x 410mm - *Does not include removable tool tray
- 60L - 550 x 460 x 335mm
- 100L - 700 x 460 x 410mm
- 140L - 915 x 460 x 440mm
- 216L - 1300 x 460 x 460mm

- IMC001
- IMC002
- IMC003
- IMC004
- IMC005



UTE BOXES - L x D x H

- 140L - 1320 x 505 x 475mm
- 200L - 1400 x 540 x 540mm

- UTEBOX001
- UTEBOX002



Accessory

Part No.

ALUMINIUM TOOL BOXES - L x D x H

- Aluminium One Tonner - 900 x 500 x 680mm
- Aluminium One Tonner - 1210 x 500 x 680mm
- Aluminium Low Profile - 950 x 600 x 500mm
- Aluminium Low Profile - 1250 x 600 x 500mm
- Aluminium Under-Tray Box - 750/520 x 270 x 440mm (LHS)
- Aluminium Under-Tray Box - 750/520 x 270 x 440mm (RHS)
- Aluminium Gull Wing Truck Box - 1770 x 550 x 400mm

- ITB001
- ITB002
- ITB003
- ITB004
- ITB007
- ITB008
- ITB009

STEEL TOOL BOXES - L x D x H

- Steel Truck Box - 700 x 640 x 750mm
- Steel Truck Box - 1210 x 640 x 750mm

- ITB005
- ITB006



Accessory **Part No.**

GENERAL ACCESSORIES - L x D x H

Twin Filtered Breather Kit	IDIFFBRE
20L Plastic Jerry Can with Tap - (350 x 170 x 460mm)	IWT001
40L Plastic Double Jerry Can with Nipple Outlet - (465 x 340 x 335mm)	IWT002
40L Vertical Water Tank with Nipple Outlet - (1100 x 75 x 700*)	IWT003
50L Roof Rack Water Tank with Nipple Outlet - (1200 x 600 x 120mm*)	IWT004
50L Wheel Arch Water Tank with Nipple Outlet - (1215 x 120 x 590mm*)	IWT005
50L Tapered Water Tank with Nipple Outlet - (1050 x 200 x 390mm*)	IWT006
60L Water Tank with Nipple Outlet - (845 x 360 x 270mm*)	IWT007
1.5m Plastic Water Hose Kit - Connects to nipple outlet on water tanks	IWTHOSE

*Includes the height of the screw cap



TWIN FILTERED BREATHER KIT



20L JERRY CAN



40L DOUBLE JERRY CAN



40L VERTICAL WATER TANK



40L ROOF RACK WATER TANK



50L WHEEL ARCH WATER TANK



50L TAPERED WATER TANK



60L WATER TANK



WATER HOSE KIT

MINING AND FLEET ACCESSORIES



HIGH VISIBILITY LIGHT BAR



HIGH MOUNT FLAG



AUTO HEADLIGHT ON KIT



LOW WATER ALARM

MINING ACCESSORIES

High Mount Flag - 1.8m (With red LED)	MINING001
High Mount Flag - 2.4m (With red LED)	MINING008
High Visibility Light Bar (With lights, reverse alarm and beacon)	MINING005
Auto Headlight On Kit (Lights on / keys on)	IALK001
Low Water Alarm (12V / 24V)	ILWA001

Accessory **Part No.**

OILSKIN COOPER JACKET

Size -S	IMCOOPBN04
Size - M	IMCOOPBN05
Size - L	IMCOOPBN06
Size - XL	IMCOOPBN07
Size - XXL	IMCOOPBN08
Size - XXXL	IMCOOPBN09
Size - XXXXL	IMCOOPBN10

OILSKIN CAPRICORN VEST

Size - S	IMCAPRIBN04
Size - M	IMCAPRIBN05
Size - L	IMCAPRIBN06
Size - XL	IMCAPRIBN07
Size - XXL	IMCAPRIBN08
Size - XXXL	IMCAPRIBN09
Size - XXXXL	IMCAPRIBN10



OILSKIN CAPRICORN VEST



OILSKIN COOPER JACKET





1988 to 1994

Accessory	Part No.
MERCHANDISE	
Ironman 4x4 Key Rings	KEY001
Ironman 4x4 Bottle Opener Key Rings	KEY002
Ironman 4x4 Stubby Holder	CAN001
Ironman 4x4 Metal Drink Bottle - Silver with Ironman 4x4 Logo	IBOTTLE001
Ironman 4x4 Metal Drink Bottle - Grey with Foam Cell Pro Logo	IBOTTLE002
The Australian 4WD Handbook	IBOOK001
Discover Oz Productions - Top Of Down Under DVD (Vol 2)	DVD001
Discover Oz Productions - Top Of Down Under DVD (Vol 3)	DVD004
Discover Oz Productions - Top Of Down Under DVD (Vol 4)	DVD006
Discover Oz Productions - Top Of Down Under DVD (Vol 5)	DVD007
Discover Oz Productions - Top Of Down Under DVD (Vol 6)	DVD008
Ironman 4x4 Adventure Challenge WA 2012	DVD002
Ironman 4x4 Adventure Challenge WA 2013	DVD003
Ironman 4x4 Adventure Challenge WA 2014	DVD005
Ironman Atlas Australia	ATLAS001
Black Ironman 4x4 Cap	CAP001

Accessory	Part No.
STEEL WINCH BULL BARS	
Black Commercial	BBC010
Deluxe Black Commercial	BBCD010
LOCKSAFE DRAWER SYSTEMS	
Twin Drawers - 1000mm	ITD1000
Single Drawer - 1000mm	ISD1000
SNORKEL	
All Models Except 2.8L Diesel	ISNORKEL011
STEEL ROOF RACKS	
Cage Style - 1.4m x 1.25m	IRRCAGE14
Cage Style - 1.8m x 1.25m	IRRCAGE18
Cage Style - 2.2m x 1.25m	IRRCAGE22
Rooftop Tent Compatible - 1.8m x 1.25m	IRRTENT18
Rooftop Tent Compatible - 2.2m x 1.25m	IRRTENT22
Trade Style - 1.8m x 1.25m (Open end)	IRRTRADE18
Trade Style - 2.2m x 1.25m (Open end)	IRRTRADE22
ALLOY ROOF RACKS	
Cage Style - 1.4m x 1.25m	IRRCAGE14-ALLOY
Cage Style - 1.8m x 1.25m	IRRCAGE18-ALLOY
Cage Style - 2.2m x 1.25m	IRRCAGE22-ALLOY
Trade Style - 1.4m x 1.25m (Open end)	IRROPEN14-ALLOY
Trade Style - 1.8m x 1.25m (Open end)	IRRTRADE18-ALLOY
Trade Style - 2.2m x 1.25m (Open end)	IRRTRADE22-ALLOY
ROOF RACK - MOUNTING KITS	
Gutter Mount Feet - 125mm (8 Feet - Does not fit high roof model)	IRRFEET125
Gutter Mount Feet - 210mm (8 Feet - Fits high roof model)	IRRFEET210
BREATHER KIT	
Universal Twin Manifold Filtered Breather Kit	IDIFFBRE



IRONMAN 4X4 KEY RINGS



IRONMAN 4X4 STUBBY HOLDER



IRONMAN 4X4 DRINK BOTTLE



CAP



DISCOVER OZ PRODUCTIONS TOP OF DOWN UNDER (DVD)



ADVENTURE CHALLENGE (DVD)



IRONMAN 4X4 THE AUSTRALIAN 4WD HANDBOOK

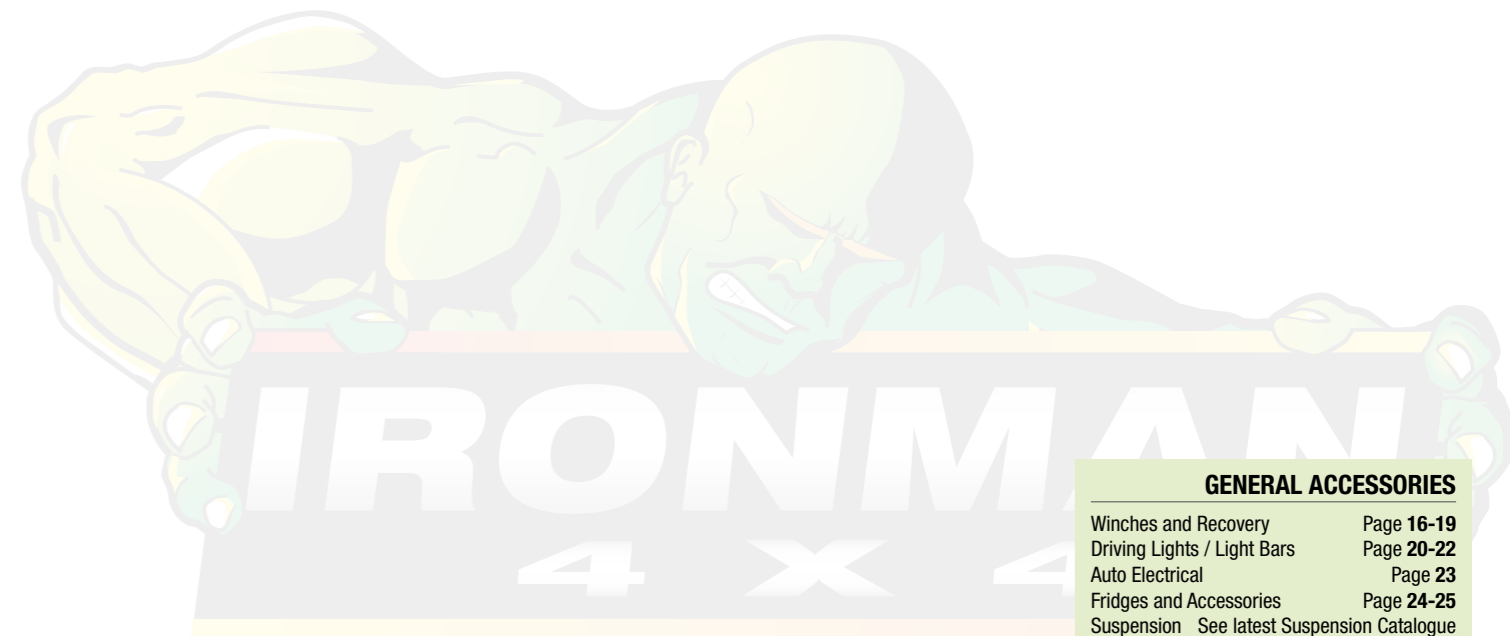

GENERAL ACCESSORIES

Winches and Recovery	Page 16-19
Driving Lights / Light Bars	Page 20-22
Auto Electrical	Page 23
Fridges and Accessories	Page 24-25
Suspension	See latest Suspension Catalogue



Accessory	Part No.
WITH TECH PACK ADAPTIVE CRUISE CONTROL - STEEL WINCH BULL BARS (AIR BAG COMPATIBLE)	
Deluxe Black Commercial - With Adaptive Cruise Control	BBCD054
Protector - With Adaptive Cruise Control	BBT054
Polished Alloy - With Adaptive Cruise Control (Released 2nd half of 2016)	BBA054
• Can also be fitted to both 2WD and 4WD models.	
WITHOUT TECH PACK ADAPTIVE CRUISE CONTROL - STEEL WINCH BULL BARS (AIR BAG COMPATIBLE)	
Black Commercial - With parking sensor provisions	BBC055
Deluxe Black Commercial - With parking sensor provisions	BBCD055
Deluxe Black Commercial	BBCD054
Protector	BBT054
Polished Alloy	BBA054
• Can also be fitted to both 2WD and 4WD models.	
STEEL SIDE STEPS, SIDE STEPS AND RAILS - Fits Dual Cab models only	
Side Steps	SS054
Side Rails	SS054 RAIL
Side Steps and Rails	SSR054
TOWING	
Class 4 Towbar - Compatible with Factory Rear Step (Not Wild Track)	TB038
Rear Protection Towbar - Full Rear Bumper Replacement	RTB038
Rear Protection Towbar Plates (Pair)	RTBPLATE001
Towbar Wiring Loom - Plug and Play (PX Mk II only)	ITBL054
LOCKSAFE DRAWER SYSTEMS - Fits Dual and Extra Cab	
Twin Drawers - 1300mm	ITD1300
Single Drawer - 1300mm	ISD1300
Wing Kit - 1300mm*	ITDW037
*Designed to suit factory tubs, will not suit ute liner without modification	
SNORKEL	
XL - (with side indicator)	ISNORKEL034
XLT - (with indicator on side mirror)	ISNORKEL034XLT
BIGBORE EXHAUST SYSTEM	
3.2L*	IEXHAUST007
2.2L	IEXHAUST020
*Does not suit vehicle with DPF	
LONG RANGE FUEL TANK - Diesel 4WD only	
140L	TANK007
PREMIUM UNDERBODY PROTECTION	
Engine Bay and Transmission	UBP054
UNDERBODY PROTECTION	
Engine Bay and Transmission	IUP014K
Fuel Tank	IUP014F
• Fuel tank protection plates are not compatible with long range fuel tanks.	

Listing continued on following page

Accessory	Part No.
CANOPY ABS PLASTIC (SIDE LIFT UP WINDOWS) - Fits 4x4 and 4x2 Dual Cab models	
	Pre-Primed CANOPY010-P
Cool White (AZW) CANOPY010-CW	Frozen White (7VT) CANOPY010-FW
Aurora Blue (39A) CANOPY010-AB	Black Mica (16W) CANOPY010-BM
Gunmetal Blue (39L) CANOPY010-GB	Metropolitan Grey (36C) CANOPY010-MG
Highlight Silver (18G) CANOPY010-S	Aluminium Metallic (38P) CANOPY010-AM
Chilli Orange (33J) CANOPY010-CO	Ingot Silver (WVR) CANOPY010-IS
Magnetic Grey (WVQ) CANOPY010-M	Shadow Black (WVS) CANOPY010-SB
True Red (A4A) CANOPY010-TR	Winning Blue (WVV) CANOPY010-WB
TUB STRENGTHENING BRACKET	
To suit ABS Plastic Canopy - (Must be fitted)	CANOPY010 BRACKET
DUAL CAB UTE LINER (COMPATIBLE WITH ABS CANOPY) - Fits 4x4 and 4x2 Dual Cab models	
Superlock kit must be used if fitting Ironman 4x4 Canopy to Ute Liner	
Ranger	LINER012
Superlock Kit	SUPERLOCK
• Not compatible with hardtop lids and factory sports bars	
SEAT COVER	
Canvas Comfort - Front	ICSC054F
Canvas Comfort - Rear	ICSC055R
BREATHER KIT	
Universal Twin Manifold Filtered Breather Kit	IDIFFBRE

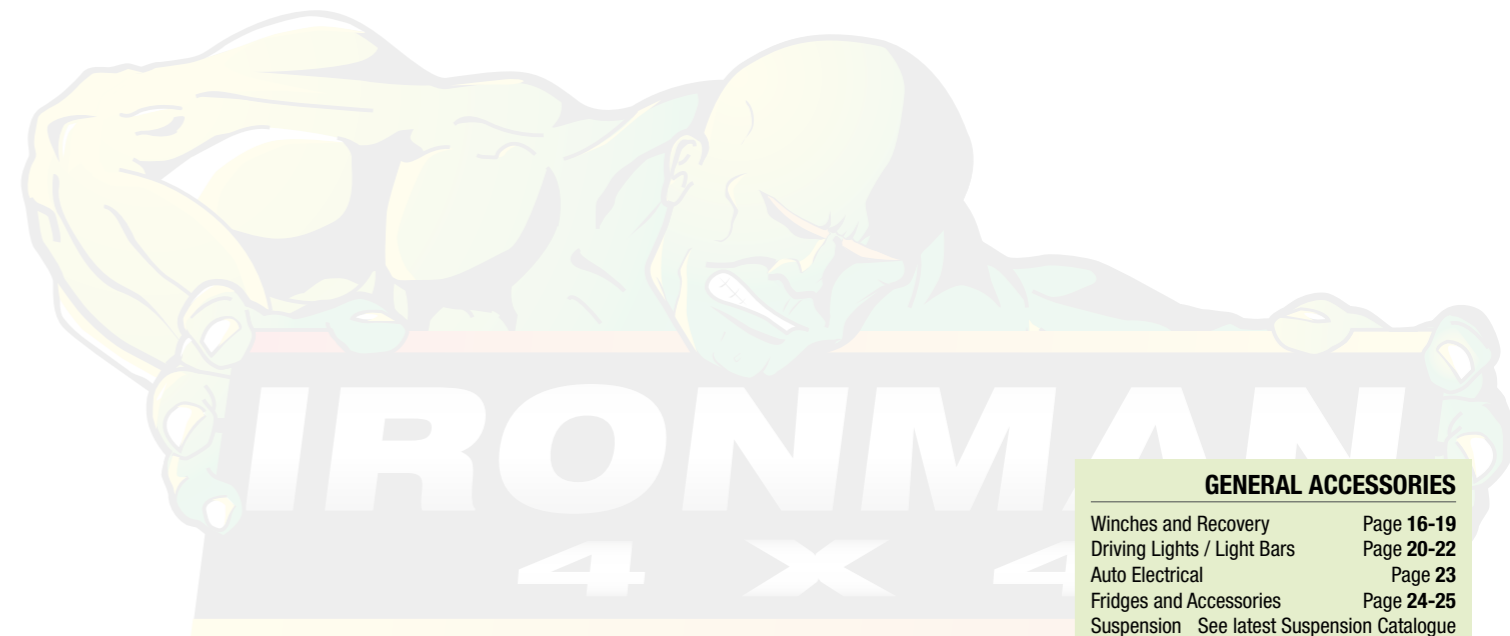

GENERAL ACCESSORIES

Winches and Recovery	Page 16-19
Driving Lights / Light Bars	Page 20-22
Auto Electrical	Page 23
Fridges and Accessories	Page 24-25
Suspension	See latest Suspension Catalogue



Accessory

Part No.

STEEL WINCH BULL BARS (AIR BAG COMPATIBLE)

Black Commercial	BBC038
Deluxe Black Commercial	BBCD038
Protector	BBT038
Polished Alloy	BBA038

• Can also be fitted to both 2WD and 4WD models.

STEEL SIDE STEPS, SIDE STEPS AND RAILS (AIR BAG COMPATIBLE) - Fits Dual Cab models only

Side Steps	SS054
Side Rails	SS054 RAIL
Side Steps and Rails	SSR054

• Will fit Extra Cab with minor modifications to rear mount

TOWING

Class 4 Towbar - Compatible with Factory Rear Step (Not Wild Track)	TB038
Rear Protection Towbar - Full Rear Bumper Replacement	RTB038
Rear Protection Towbar Plates (Pair)	RTBPLATE001
Towbar Wiring Loom - Plug and Play (PX 7/11 to 4/14 only)	ITBL039
Towbar Wiring Loom - Plug and Play (PX 4/14 to 7/15 only)	ITBL038

LOCKSAFE DRAWER SYSTEMS

Twin Drawers - 1300mm	ITD1300
Single Drawer - 1300mm	ISD1300
Wing Kit - 1300mm*	ITDW037

*Designed to suit factory tubs, will not suit ute liner without modification

SNORKEL

2.2 / 3.2L Diesel (Fits XL with side indicator)	ISNORKELO34
2.2 / 3.2L Diesel (Fits XLT with indicator on side mirror)	ISNORKELO34XLT

BIGBORE EXHAUST SYSTEM

PX Ranger 3.2L Diesel	IEXHAUST007
PX Ranger 2.2L Diesel	IEXHAUST020

LONG RANGE FUEL TANK

140L	TANK007
------	----------------

PREMIUM UNDERBODY PROTECTION

Engine Bay and Transmission	UBP054
-----------------------------	---------------

UNDERBODY PROTECTION

Engine Bay and Transmission	IUP014K
Fuel Tank	IUP014F

• Fuel tank protection plates are not compatible with long range fuel tanks.

Accessory

Part No.

CANOPY ABS PLASTIC (SIDE LIFT UP WINDOWS) - Fits 4x4 and 4x2 Dual Cab models

		Pre-Primed	CANOPY010-P
Cool White (AZW)	CANOPY010-CW	Frozen White (7VT)	CANOPY010-FW
Aurora Blue (39A)	CANOPY010-AB	Black Mica (16W)	CANOPY010-BM
Gunmetal Blue (39L)	CANOPY010-GB	Metropolitan Grey (36C)	CANOPY010-MG
Highlight Silver (18G)	CANOPY010-S	Aluminium Metallic (38P)	CANOPY010-AM
Chilli Orange (33J)	CANOPY010-CO	Ingot Silver (WVR)	CANOPY010-IS
Magnetic Grey (WVQ)	CANOPY010-M	Shadow Black (WVS)	CANOPY010-SB
True Red (A4A)	CANOPY010-TR	Winning Blue (WVV)	CANOPY010-WB

TUB STRENGTHENING BRACKET

To suit ABS Plastic Canopy - (Must be fitted)

CANOPY010 BRACKET

DUAL CAB UTE LINER (COMPATIBLE WITH ABS CANOPY) - Fits 4x4 and 4x2 Dual Cab models Superlock kit must be used if fitting Ironman 4x4 Canopy to Ute Liner

PX Ranger 2011+	LINER012
Superlock Kit	SUPERLOCK

• Not compatible with hardtop lids and factory sports bars.

SEAT COVER

Canvas Comfort - Front	ICSC038F
Canvas Comfort - Rear	ICSC038R

BREATHER KIT

Universal Twin Manifold Filtered Breather Kit	IDIFFBRE
---	-----------------

Listing continued on following page

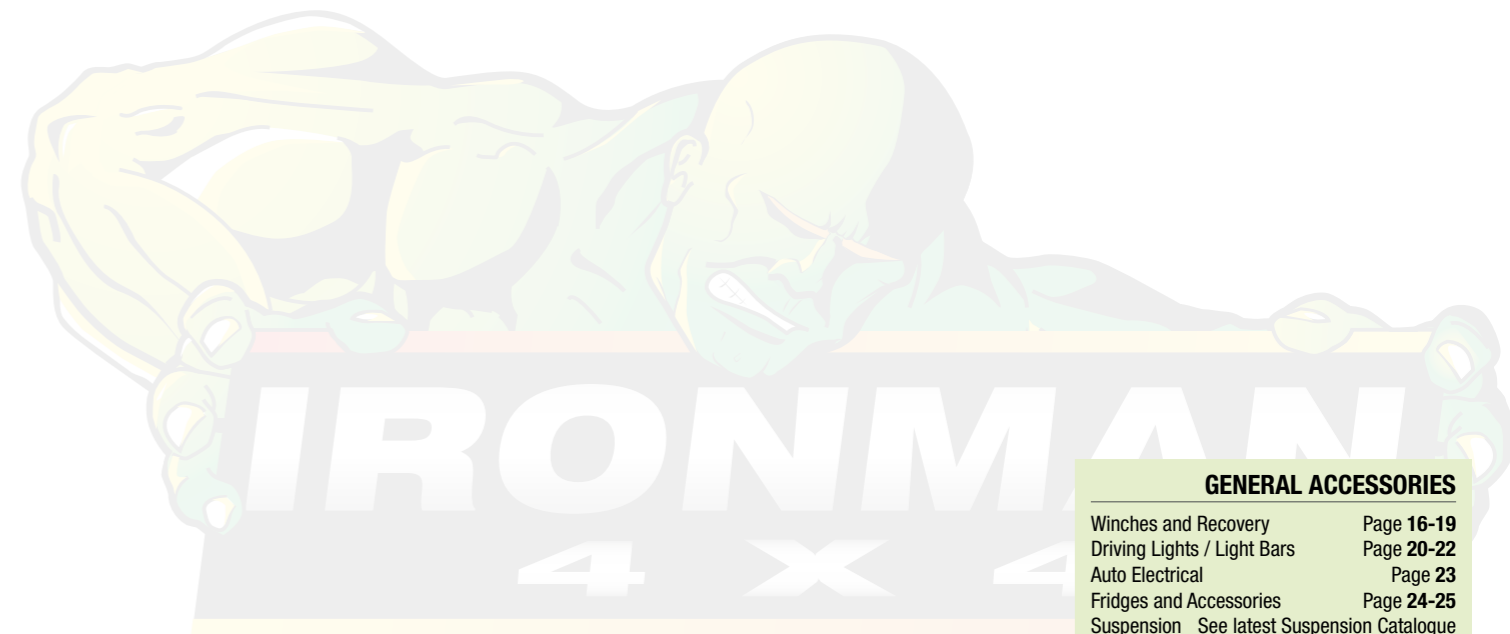

GENERAL ACCESSORIES

Winches and Recovery	Page 16-19
Driving Lights / Light Bars	Page 20-22
Auto Electrical	Page 23
Fridges and Accessories	Page 24-25
Suspension	See latest Suspension Catalogue



Accessory	Part No.
STEEL WINCH BULL BARS (AIR BAG COMPATIBLE)	
Black Commercial	BBC014
Deluxe Black Commercial	BBCD014
Protector	BBT014
• Can also be fitted to both 2WD and 4WD models.	
STEEL SIDE STEPS, SIDE STEPS AND RAILS - Fits Dual Cab models only	
Side Steps	SS008
Side Steps and Rails	SSR002
LOCKSAFE DRAWER SYSTEMS - Fits Dual and Extra Cab	
Twin Drawers - 1300mm	ITD1300
Single Drawer - 1300mm	ISD1300
SNORKEL	
3.0L TDi Diesel	ISNORKEL021
BIGBORE EXHAUST SYSTEM - Diesel Only	
Ranger (Automatic Transmission)	IEXHAUST014
Ranger (Manual Transmission)	IEXHAUST015
LONG RANGE FUEL TANK - Fits Dual and Single Cab only	
122L	TANK006
UNDERBODY PROTECTION	
Engine Bay and Transmission	IUP008K
CANOPY ABS PLASTIC (SIDE LIFT UP WINDOWS) - Fits 4x4 and 4x2 Dual Cab models	
Pre-Primed	CANOPY004-P
Ranger White (AZW)	CANOPY004-W
DUAL CAB UTE LINER (COMPATIBLE WITH ABS CANOPY) - Fits 4x4 and 4x2 Dual Cab models	
Superlock kit must be used if fitting Ironman 4x4 Canopy to Ute Liner	
Ranger 2006 to 2011	LINER003
Superlock Kit	SUPERLOCK
• Not compatible with hardtop lids and factory sports bars.	
BREATHER KIT	
Universal Twin Manifold Filtered Breather Kit	IDIFFBRE

Accessory	Part No.
WITH TECH PACK ADAPTIVE CRUISE CONTROL - STEEL WINCH BULL BARS (AIR BAG COMPATIBLE)	
Deluxe Black Commercial - With Adaptive Cruise Control	BBCD054
Protector - With Adaptive Cruise Control	BBT054
Polished Alloy - With Adaptive Cruise Control (Released 2nd half of 2016)	BBA054
• Can also be fitted to both 2WD and 4WD models.	
WITHOUT TECH PACK ADAPTIVE CRUISE CONTROL - STEEL WINCH BULL BARS (AIR BAG COMPATIBLE)	
Black Commercial - With parking sensor provisions	BBC055
Deluxe Black Commercial - With parking sensor provisions	BBCD055
Deluxe Black Commercial	BBCD054
Protector	BBT054
Polished Alloy	BBA054
• Can also be fitted to both 2WD and 4WD models.	
STEEL SIDE STEPS, SIDE STEPS AND RAILS	
Side Steps	SS055
Side Rails	SS055 RAIL
Side Steps and Rails	SSR055
PREMIUM UNDERBODY PROTECTION	
Engine Bay and Transmission	UBP054
UNDERBODY PROTECTION	
Engine Bay and Transmission	IUP014K
Fuel Tank	IUP014F
• Fuel tank protection plates are not compatible with long range fuel tanks.	
SEAT COVER	
Canvas Comfort - Front	ICSC054F
Canvas Comfort - Rear	ICSC054R
BREATHER KIT	
Universal Twin Manifold Filtered Breather Kit	IDIFFBRE

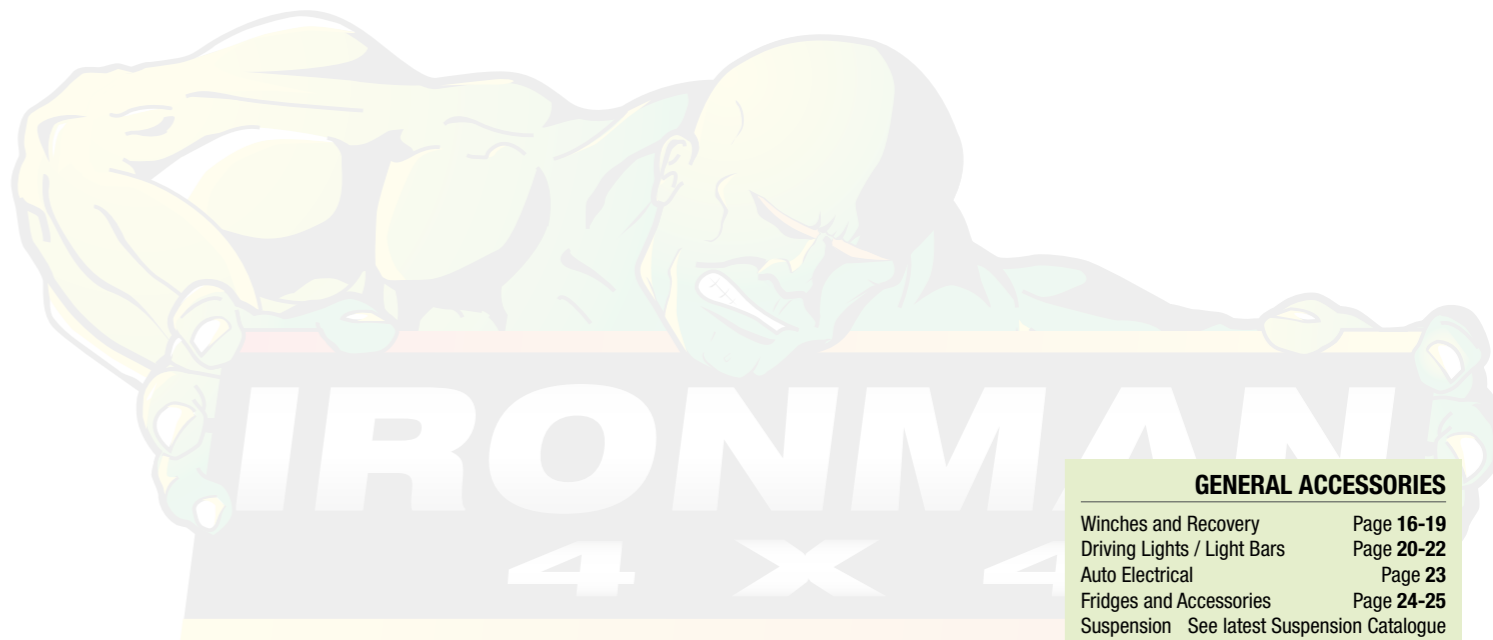

GENERAL ACCESSORIES	
Winches and Recovery	Page 16-19
Driving Lights / Light Bars	Page 20-22
Auto Electrical	Page 23
Fridges and Accessories	Page 24-25
Suspension	See latest Suspension Catalogue



Accessory

Part No.

STEEL WINCH BULL BARS (AIR BAG COMPATIBLE)

Black Commercial	BBC057
Deluxe Black Commercial	BBCD057
Protector	BBT057

• Can also be fitted to both 2WD and 4WD models.

STEEL SIDE STEPS, SIDE STEPS AND RAILS (AIR BAG COMPATIBLE) - Fits Dual Cab models only

Side Steps	SS044
Side Rails	SS044 RAIL
Side Steps and Rails	SSR044

SNORKEL

Trailblazer LT/LTZ 2017+	ISNORKEL036
--------------------------	-------------

PREMIUM UNDERBODY PROTECTION

Engine Bay and Transmission	UBP057
-----------------------------	--------

STEEL ROOF RACKS

Cage Style - 1.8 x 1.25m	IRRCAGE18
Rooftop Tent Compatible - 1.8 x 1.25m	IRRTENT18
Trade Style - 1.8m x 1.25m (Open end)	IRRTRADE18

ALLOY ROOF RACKS

Cage Style - 1.8m x 1.25m	IRRCAGE18-ALLOY
Trade Style - 1.8m x 1.25m (Open end)	IRRTRADE18-ALLOY

ROOF RACK - MOUNTING KITS

Holden Colorado 7 Mount Feet (6 Feet)	IRRFEET001
---------------------------------------	------------

SEAT COVER

Canvas Comfort - Front	ICSC040F
------------------------	----------

BREATHER KIT

Universal Twin Manifold Filtered Breather Kit	IDIFFBRE
---	----------

Accessory

Part No.

STEEL WINCH BULL BARS (AIR BAG COMPATIBLE)

Black Commercial	BBC057
Deluxe Black Commercial	BBCD057
Protector	BBT057

• Can also be fitted to both 2WD and 4WD models.

STEEL SIDE STEPS, SIDE STEPS AND RAILS (AIR BAG COMPATIBLE) - Fits Dual Cab models only

Side Steps	SS057
Side Rails	SS057 RAIL
Side Steps and Rails	SSR057

TOWING

Class 4 Towbar - Compatible with Factory Rear Step	TB040
Rear Protection Towbar - Full Rear Bumper Replacement	RTB040
Rear Protection Towbar Plates (Pair)	RTBPLATE002
Towbar Wiring Loom - Plug and Play	ITBL040

LOCKSAFE DRAWER SYSTEMS

Twin Drawers - 1300mm	ITD1300
Single Drawer - 1300mm	ISD1300
Wing Kit - 1300mm*	ITDW038

*Designed to suit factory tubs, will not suit ute liner without modification

SNORKEL

Colorado RG 2016+	ISNORKEL036
-------------------	-------------

BIGBORE EXHAUST SYSTEM

2.8L Turbo Diesel	IEXHAUST017
-------------------	-------------

PREMIUM UNDERBODY PROTECTION

Engine Bay and Transmission	UBP057
-----------------------------	--------

CANOPY ABS PLASTIC (SIDE LIFT UP WINDOWS) - Fits 4x4 and 4x2 Dual Cab models

Pre-Primed	CANOPY019-P
Summit White (8624)	CANOPY019-SW
Steel Grey (GYM)	CANOPY019-G

DUAL CAB UTE LINER (COMPATIBLE WITH ABS CANOPY) - Fits 4x4 and 4x2 Dual Cab models Superlock kit must be used if fitting Ironman 4x4 Canopy to Ute Liner

Colorado RG 2016+	LINER013
Superlock Kit	SUPERLOCK

• Not compatible with hardtop lids and factory sports bars.

SEAT COVER

Canvas Comfort - Front	ICSC040F
Canvas Comfort - Rear	ICSC040R

BREATHER KIT

Universal Twin Manifold Filtered Breather Kit	IDIFFBRE
---	----------

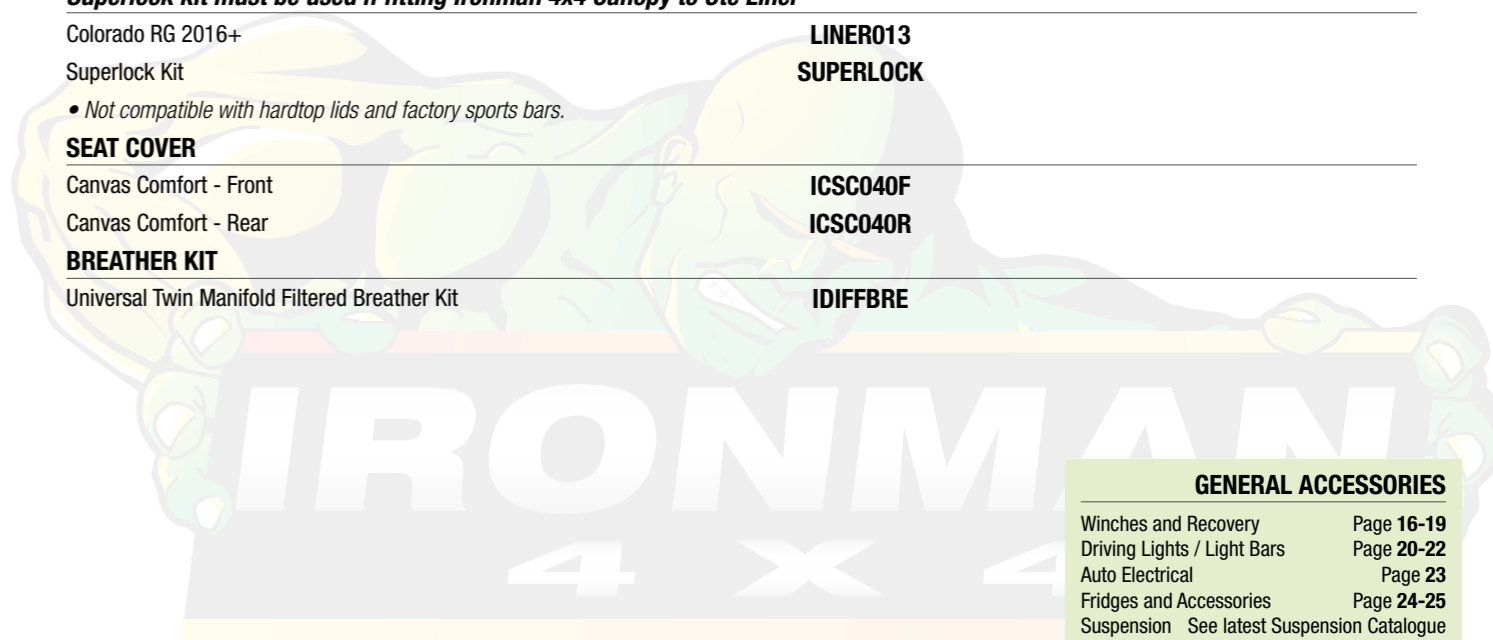

GENERAL ACCESSORIES

Winches and Recovery	Page 16-19
Driving Lights / Light Bars	Page 20-22
Auto Electrical	Page 23
Fridges and Accessories	Page 24-25
Suspension	See latest Suspension Catalogue

HOLDEN

HOLDEN



Accessory	Part No.
STEEL WINCH BULL BARS (AIR BAG COMPATIBLE)	
Black Commercial	BBC040
Deluxe Black Commercial	BBCD040
Protector	BBT040
• Can also be fitted to both 2WD and 4WD models.	
STEEL SIDE STEPS, SIDE STEPS AND RAILS (AIR BAG COMPATIBLE) - Fits Dual Cab models only	
Side Steps	SS040
Side Steps and Rails	SSR040
TOWING	
Class 4 Towbar - Compatible with Factory Rear Step	TB040
Rear Protection Towbar - Full Rear Bumper Replacement	RTB040
Rear Protection Towbar Plates (Pair)	RTBPLATE002
Towbar Wiring Loom - Plug and Play	ITBL040
LOCKSAFE DRAWER SYSTEMS	
Twin Drawers - 1300mm	ITD1300
Single Drawer - 1300mm	ISD1300
Wing Kit - 1300mm*	ITDW038
*Designed to suit factory tubs, will not suit ute liner without modification	
SNORKEL	
Colorado RG 2012-11/2016	ISNORKELO36
BIGBORE EXHAUST SYSTEM	
2.8L Turbo Diesel	IEXHAUST017
PREMIUM UNDERBODY PROTECTION	
Engine Bay and Transmission	UBP041
CANOPY ABS PLASTIC (SIDE LIFT UP WINDOWS) - Fits 4x4 and 4x2 Dual Cab models	
Summit White (8624) Pre-Primed CANOPY012-SW	CANOPY012-P
Oceanic Blue (774V) CANOPY012-B	Black Sapphire (240) CANOPY012-BS
	Silver (636E) CANOPY012-S
DUAL CAB UTE LINER (COMPATIBLE WITH ABS CANOPY) - Fits 4x4 and 4x2 Dual Cab models	
Superlock kit must be used if fitting Ironman 4x4 Canopy to Ute Liner	
Colorado RG 2012+	LINER013
Superlock Kit	SUPERLOCK
• Not compatible with hardtop lids and factory sports bars.	
REAR SPORTS BAR	
3" Steel Rear Sports Bar	RSB004
SEAT COVER	
Canvas Comfort - Front	ICSC040F
Canvas Comfort - Rear	ICSC040R
BREATHER KIT	
Universal Twin Manifold Filtered Breather Kit	IDIFFBRE

Accessory	Part No.
STEEL WINCH BULL BARS (AIR BAG COMPATIBLE)	
Black Commercial	BBC044
Deluxe Black Commercial	BBCD044
Protector	BBT044
• Can also be fitted to both 2WD and 4WD models.	
STEEL SIDE STEPS, SIDE STEPS AND RAILS (AIR BAG COMPATIBLE)	
Side Steps	SS044
Side Rails	SS044 RAIL
Side Steps and Rails	SSR044
SNORKEL	
Colorado 7 RG 2012+	ISNORKELO36
PREMIUM UNDERBODY PROTECTION	
Engine Bay and Transmission	UBP041
STEEL ROOF RACKS	
Cage Style - 1.8 x 1.25m	IRRCAGE18
Rooftop Tent Compatible - 1.8 x 1.25m	IRR TENT18
Trade Style - 1.8m x 1.25m (Open end)	IRR TRADE18
ALLOY ROOF RACKS	
Cage Style - 1.8m x 1.25m	IRRCAGE18-ALLOY
Trade Style - 1.8m x 1.25m (Open end)	IRR TRADE18-ALLOY
ROOF RACK - MOUNTING KITS	
Holden Colorado 7 Mount Feet (6 Feet)	IRRF EET001
SEAT COVER	
Canvas Comfort - Front	ICSC040F
BREATHER KIT	
Universal Twin Manifold Filtered Breather Kit	IDIFFBRE

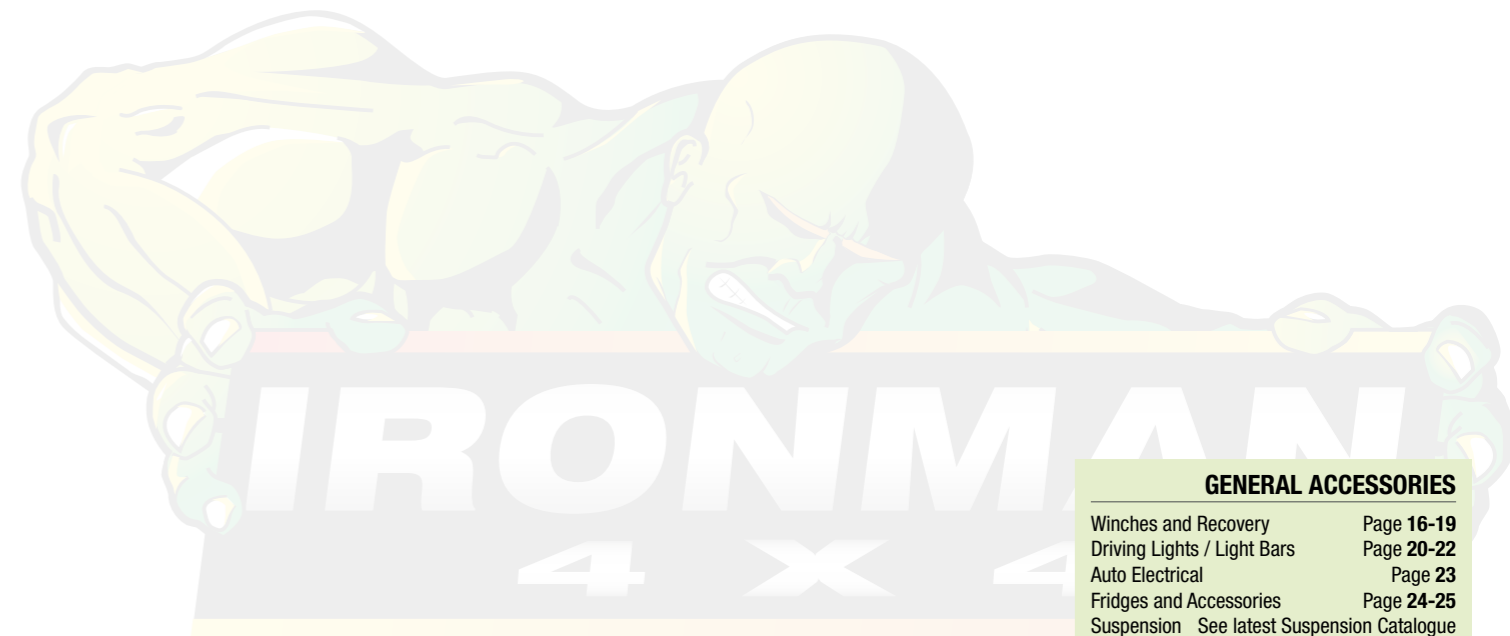

GENERAL ACCESSORIES	
Winches and Recovery	Page 16-19
Driving Lights / Light Bars	Page 20-22
Auto Electrical	Page 23
Fridges and Accessories	Page 24-25
Suspension	See latest Suspension Catalogue

RC 7/2008 to 12/2012



RA7 2007 to 7/2008

Accessory

Part No.

STEEL WINCH BULL BARS (AIR BAG COMPATIBLE)

Black Commercial	BBC027
Deluxe Black Commercial	BBCD027
Protector	BBT027

• Can also be fitted to both 2WD and 4WD models.

STEEL SIDE STEPS, SIDE STEPS AND RAILS - Fits Dual Cab models only

Side Steps	SS001
Side Steps Rails	SSR006

LOCKSAFE DRAWER SYSTEMS

Twin Drawers - 1300mm	ITD1300
Single Drawer - 1300mm	ISD1300

SNORKEL

Colorado RC 2008 to 2012	ISNORKEL028
--------------------------	--------------------

UNDERBODY PROTECTION

Engine Bay and Transmission	IUP009K
-----------------------------	----------------

CANOPY ABS PLASTIC (SIDE LIFT UP WINDOWS)

White (877) CANOPY006-W	Pre-Primed CANOPY006-P	Black (935) CANOPY006-B
--------------------------------	-------------------------------	--------------------------------

DUAL CAB UTE LINER (COMPATIBLE WITH ABS CANOPY) - Fits 4x4 and 4x2 Dual Cab models
Superlock kit must be used if fitting Ironman 4x4 Canopy to Ute Liner

Colorado RC 2008 to 2012	LINER005
Superlock Kit	SUPERLOCK

• Not compatible with hardtop lids and factory sports bars.

BREATHER KIT

Universal Twin Manifold Filtered Breather Kit	IDIFFBRE
---	-----------------

Accessory

Part No.

STEEL WINCH BULL BARS (AIR BAG COMPATIBLE)

Black Commercial	BBC020
Deluxe Black Commercial	BBCD020
Protector	BBT020

• Can also be fitted to both 2WD and 4WD models.

STEEL SIDE STEPS, SIDE STEPS AND RAILS - Fits Dual Cab models only

Side Steps	SS001
Side Steps and Rails	SSR006

LOCKSAFE DRAWER SYSTEMS

Twin Drawers - 1300mm	ITD1300
Single Drawer - 1300mm	ISD1300

SNORKEL

LX and LT (Does not fit DX model)	ISNORKEL022
-----------------------------------	--------------------

UNDERBODY PROTECTION

Engine Bay and Transmission	IUP009K
-----------------------------	----------------

CANOPY ABS PLASTIC (SIDE LIFT UP WINDOWS) - Fits 4x4 and 4x2 Dual Cab models

White (877) CANOPY006-W	Pre-Primed CANOPY006-P	Black (935) CANOPY006-B
--------------------------------	-------------------------------	--------------------------------

DUAL CAB UTE LINER (COMPATIBLE WITH ABS CANOPY) - Fits 4x4 and 4x2 Dual Cab models
Superlock kit must be used if fitting Ironman 4x4 Canopy to Ute Liner

Rodeo RA7 2007 to 2008	LINER005
Superlock Kit	SUPERLOCK

• Not compatible with hardtop lids and factory sports bars.

BREATHER KIT

Universal Twin Manifold Filtered Breather Kit	IDIFFBRE
---	-----------------

HOLDEN

HOLDEN

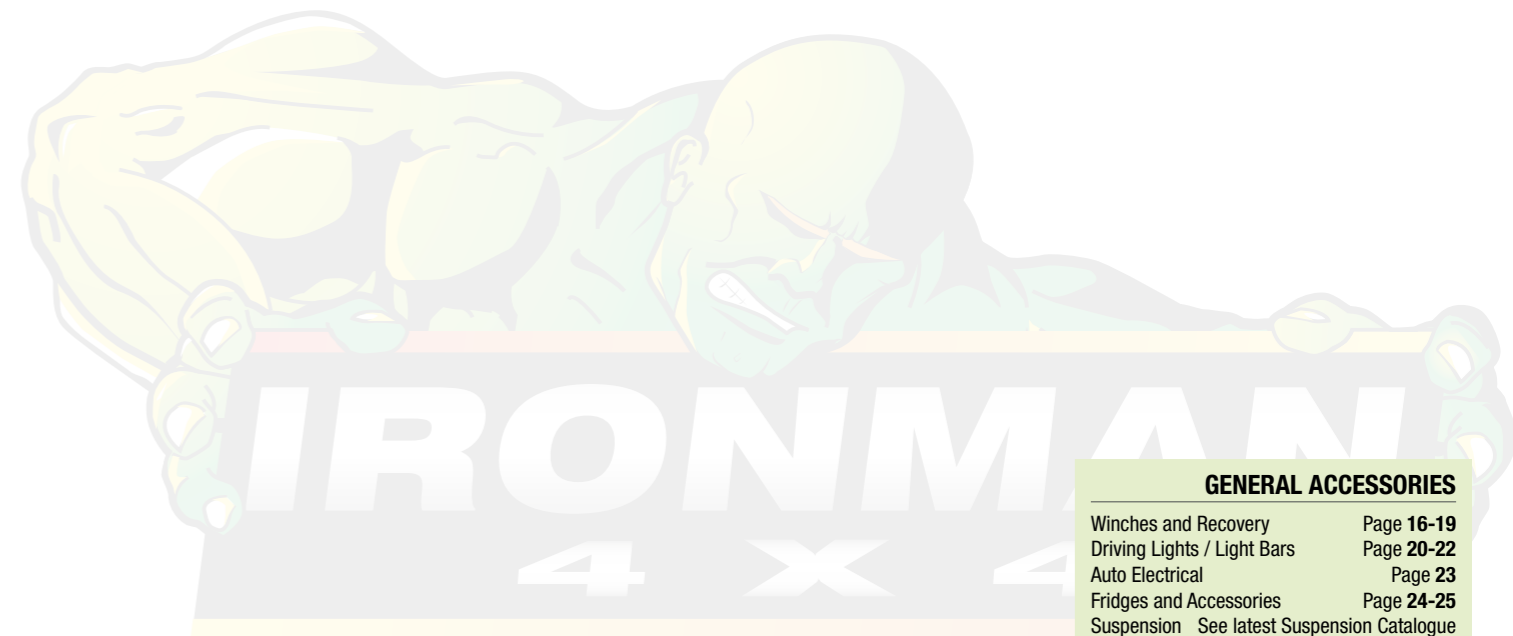

GENERAL ACCESSORIES

Winches and Recovery	Page 16-19
Driving Lights / Light Bars	Page 20-22
Auto Electrical	Page 23
Fridges and Accessories	Page 24-25
Suspension	See latest Suspension Catalogue

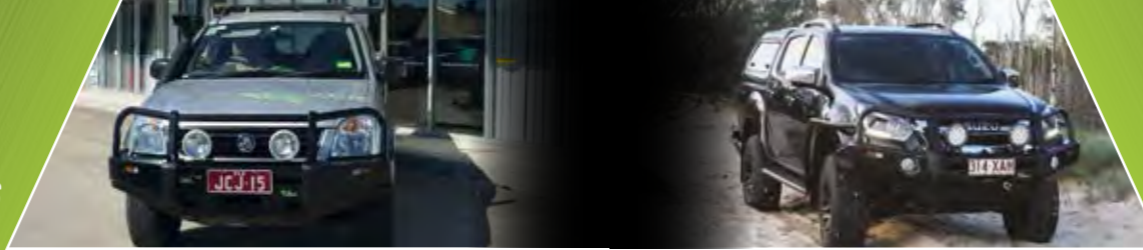

HOLDEN

ISUZU

Accessory	Part No.
STEEL WINCH BULL BARS (AIR BAG COMPATIBLE)	
Deluxe Black Commercial	BBCD003
• Can also be fitted to both 2WD and 4WD models.	
STEEL SIDE STEPS, SIDE STEPS AND RAILS - Fits Dual Cab models only	
Side Steps	SS001
Side Steps and Rails	SSR006
LOCKSAFE DRAWER SYSTEMS	
Twin Drawers - 1300mm	ITD1300
Single Drawer - 1300mm	ISD1300
UNDERBODY PROTECTION	
Engine Bay and Transmission	IUP009K
CANOPY ABS PLASTIC (SIDE LIFT UP WINDOWS) - Fits 4x4 and 4x2 Dual Cab models	
	Pre-Primed CANOPY006-P
White (877) CANOPY006-W	Black (935) CANOPY006-B
DUAL CAB UTE LINER (COMPATIBLE WITH ABS CANOPY) - Fits 4x4 and 4x2 Dual Cab models	
Superlock kit must be used if fitting Ironman 4x4 Canopy to Ute Liner	
Rodeo RA 2002 to 2006	LINER005
Superlock Kit	SUPERLOCK
• Not compatible with hardtop lids and factory sports bars.	
BREATHER KIT	
Universal Twin Manifold Filtered Breather Kit	IDIFFBRE

Accessory	Part No.
STEEL WINCH BULL BARS (AIR BAG COMPATIBLE) - Will not fit Narrow Body	
Black Commercial	BBC058
Deluxe Black Commercial	BBCD058
Protector	BBT058
• Can also be fitted to both 2WD and 4WD models.	
STEEL SIDE STEPS, SIDE STEPS AND RAILS (AIR BAG COMPATIBLE) - Fits Dual Cab models only	
Side Steps	SS058
Side Rails	SS058 RAIL
Side Steps and Rails	SSR058
TOWING	
Class 4 Towbar - Compatible with Factory Rear Step	TB041
Rear Protection Towbar - Full Rear Bumper Replacement	RTB041
Rear Protection Towbar Plates (Pair)	RTBPLATE002
Towbar Wiring Loom - Plug and Play	ITBL041
LOCKSAFE DRAWER SYSTEMS	
Twin Drawers - 1300mm	ITD1300
Single Drawer - 1300mm	ISD1300
Wing Kit - 1300mm*	ITDOW38
*Designed to suit factory tubs, will not suit ute liner without modification	
PREMIUM UNDERBODY PROTECTION	
Engine Bay and Transmission	UBP041
CANOPY ABS PLASTIC (SIDE LIFT UP WINDOWS) - Fits 4x4 and 4x2 Dual Cab models	
	Pre-Primed CANOPY020-P
Summit White (527) CANOPY020-SW	Cosmic Black (523) CANOPY020-CB
DUAL CAB UTE LINER (COMPATIBLE WITH ABS CANOPY) - Fits 4x4 and 4x2 Dual Cab models	
Superlock kit must be used if fitting Ironman 4x4 Canopy to Ute Liner	
D-MAX 2017+	LINER020
Superlock Kit	SUPERLOCK
• Not compatible with hardtop lids and factory sports bars.	
SEAT COVER	
Canvas Comfort - Front	ICSC040F
Canvas Comfort - Rear	ICSC040R
BREATHER KIT	
Universal Twin Manifold Filtered Breather Kit	IDIFFBRE

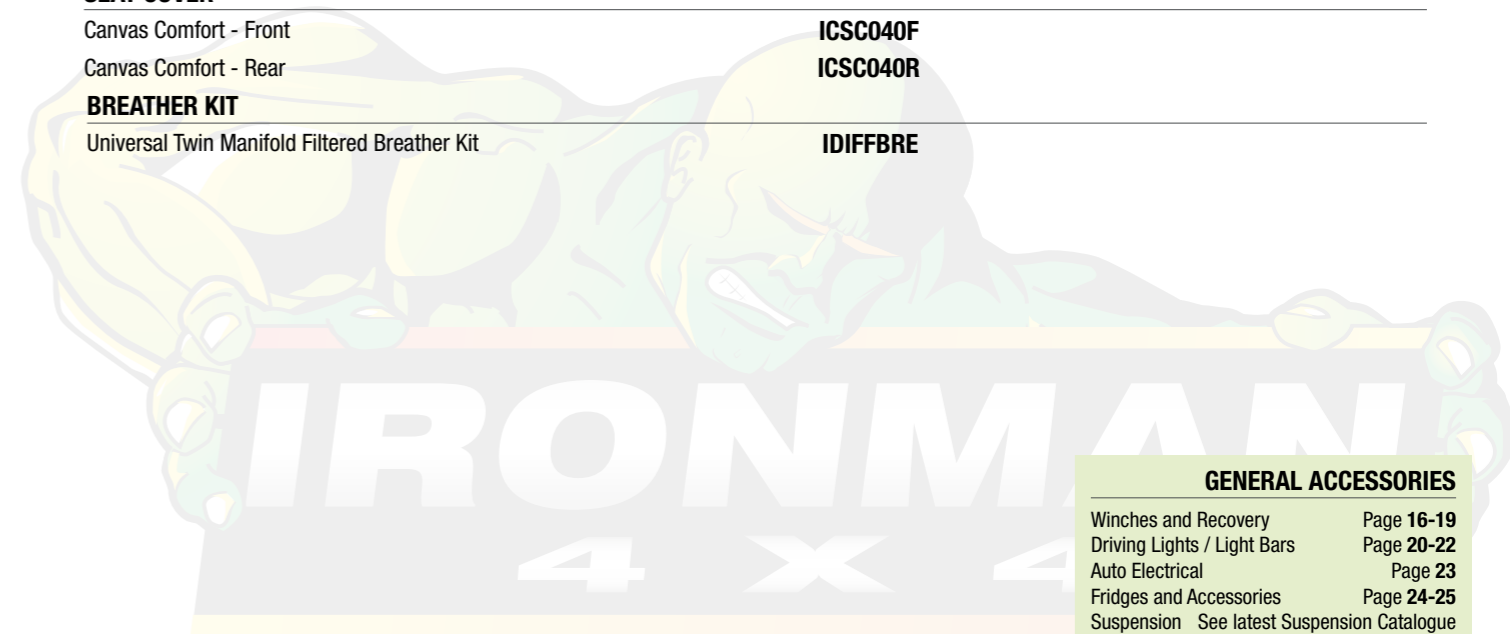

GENERAL ACCESSORIES	
Winches and Recovery	Page 16-19
Driving Lights / Light Bars	Page 20-22
Auto Electrical	Page 23
Fridges and Accessories	Page 24-25
Suspension	See latest Suspension Catalogue



Accessory	Part No.
STEEL WINCH BULL BARS (AIR BAG COMPATIBLE) - WILL NOT FIT NARROW BODY	
Black Commercial	BBC041
Deluxe Black Commercial	BBCD041
Protector	BBT041
• Can also be fitted to both 2WD and 4WD models.	
STEEL SIDE STEPS, SIDE STEPS AND RAILS (AIR BAG COMPATIBLE)	
Side Steps	SS041
Side Steps and Rails	SSR041
TOWING	
Class 4 Towbar - Compatible with Factory Rear Step	TB041
Rear Protection Towbar - Full Rear Bumper Replacement	RTB041
Rear Protection Towbar Plates (Pair)	RTBPLATE002
Towbar Wiring Loom - Plug and Play	ITBL041
LOCKSAFE DRAWER SYSTEMS	
Twin Drawers - 1300mm	ITD1300
Single Drawer - 1300mm	ISD1300
Wing Kit - 1300mm*	IWING038
*Designed to suit factory tubs, will not suit ute liner without modification	
BIGBORE EXHAUST SYSTEM	
3ltr Turbo Diesel	IEXHAUST016
PREMIUM UNDERBODY PROTECTION	
Engine Bay and Transmission	UBP041
CANOPY ABS PLASTIC (SIDE LIFT UP WINDOWS) - Fits 4x4 and 4x2 Dual Cab models	
Pre-Primed	CANOPY011-P
Splash White (SW) (527)	CANOPY011-SW
DUAL CAB UTE LINER (COMPATIBLE WITH ABS CANOPY) - Fits 4x4 and 4x2 Dual Cab models	
Superlock kit must be used if fitting Ironman 4x4 Canopy to Ute Liner	
D-MAX 2012 to 1/2017	LINER014
Superlock Kit	SUPERLOCK
• Not compatible with hardtop lids and factory sports bars.	
SEAT COVER	
Canvas Comfort - Front	ICSC040F
Canvas Comfort - Rear	ICSC040R
BREATHER KIT	
Universal Twin Manifold Filtered Breather Kit	IDIFFBRE

Accessory	Part No.
STEEL WINCH BULL BARS (AIR BAG COMPATIBLE)	
Black Commercial	BBC020
Deluxe Black Commercial	BBCD020
Protector	BBT020
• Can also be fitted to both 2WD and 4WD models.	
STEEL SIDE STEPS, SIDE STEPS AND RAILS - Fits Dual Cab models only	
Side Steps	SS001
Side Steps and Rails	SSR006
LOCKSAFE DRAWER SYSTEMS	
Twin Drawers - 1300mm	ITD1300
Single Drawer - 1300mm	ISD1300
SNORKEL	
D-MAX 2009+ (Does not fit 4x2 SX model)	ISNORKEL022
UNDERBODY PROTECTION	
Engine Bay and Transmission	IUP009K
CANOPY ABS PLASTIC (SIDE LIFT UP WINDOWS) - Fits 4x4 and 4x2 Dual Cab models	
Pre-Primed	CANOPY006-P
White (877)	CANOPY006-W
Black (935)	CANOPY006-B
DUAL CAB UTE LINER (COMPATIBLE WITH ABS CANOPY) - Fits 4x4 and 4x2 Dual Cab models	
Superlock kit must be used if fitting Ironman 4x4 Canopy to Ute Liner	
D-MAX 2007 to 2012	LINER005
Superlock Kit	SUPERLOCK
• Not compatible with hardtop lids and factory sports bars.	
BREATHER KIT	
Universal Twin Manifold Filtered Breather Kit	IDIFFBRE

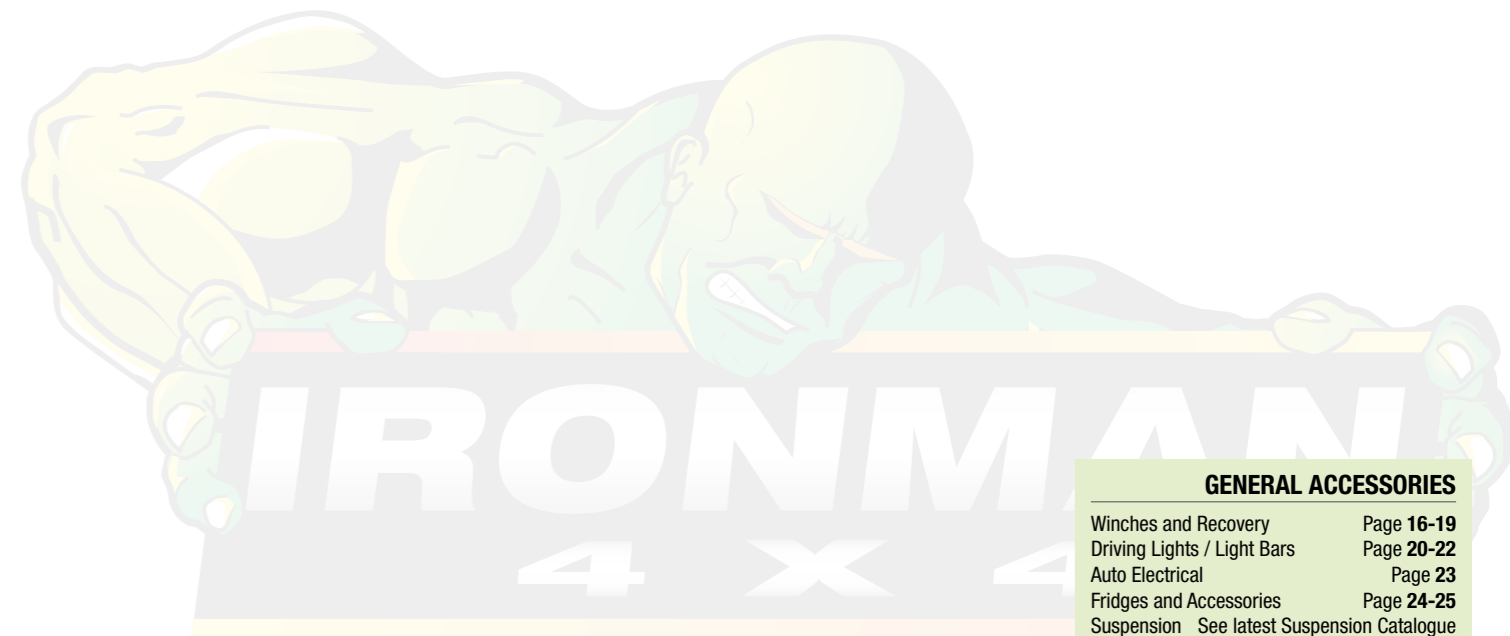

GENERAL ACCESSORIES	
Winches and Recovery	Page 16-19
Driving Lights / Light Bars	Page 20-22
Auto Electrical	Page 23
Fridges and Accessories	Page 24-25
Suspension	See latest Suspension Catalogue

NEW INSTANT AWNINGS

FROM IRONMAN 4X4



- Built from 280gsm rip stop UV50+ rated poly cotton
- Flexible nylon joints
- Twist lock poles
- Integrated LED light strip with dimmer
- Glow in the dark guy ropes
- 1000D PVC cover

1.4M X 2.5M 2M X 2.5M 2.5M X 2.5M

NEW CAMPING AND LEISURE CHAIRS

Deluxe Lounge

- Fully enclosed design keeps your back warm
- Extra padding for increased comfort
- Wide design for real lounge comfort
- Integrated can holder pocket

150kg WEIGHT CAPACITY

Deluxe Hard Arm

- Rear locking tabs lock chair open or closed
- Strong and durable solid arms with high strength steel frame
- Includes integrated side can holder
- Lightweight and easy to carry

150kg WEIGHT CAPACITY

Deluxe Soft Arm

- High strength steel frame with soft durable arms
- Integrated can holder and insulated pocket in each arm
- Handy side utility pocket
- Lightweight and easy to carry

150kg WEIGHT CAPACITY

Quick Fold Stretcher

- Includes carry bag for easy storage and portability
- Integrated foot and head padding
- Heavy duty material construction
- Opens and folds in 2 seconds
- High strength steel frame

150kg WEIGHT CAPACITY

Mid Sized Low Back

- Compact design
- Lightweight and easy to carry
- Ideal for juniors
- Opens and folds in seconds

130kg WEIGHT CAPACITY



SAFER, STRONGER, SMARTER

Prices do not include freight or fitting and are subject to change without notice.



2014 to 2/2017
(Facelift) 3/2017+

Accessory

Part No.

STEEL WINCH BULL BARS (AIR BAG COMPATIBLE) - Fits 4x4 and 4x2 models	2014 TO 2/2017
Deluxe Black Commercial	BBCD049
STEEL WINCH BULL BARS (AIR BAG COMPATIBLE) - Fits 4x4 and 4x2 models	3/2017 (FACELIFT)
Deluxe Black Commercial	BBCD061
STEEL SIDE STEPS, SIDE STEPS AND RAILS (AIR BAG COMPATIBLE)	
Side Steps	SS044
Side Rails	SS044 RAIL
Side Steps and Rails	SSR044
PREMIUM UNDERBODY PROTECTION	
Engine Bay and Transmission	UBP041
STEEL ROOF RACKS	
Cage Style - 1.8m x 1.25m	IRRCAGE18
Rooftop Tent Compatible - 1.8m x 1.25m	IRRTENT18
Trade Style - 1.8m x 1.25m (Open end)	IRRTRADE18
ALLOY ROOF RACKS	
Cage Style - 1.8m x 1.25m	IRRCAGE18-ALLOY
Trade Style - 1.8m x 1.25m (Open end)	IRRTRADE18-ALLOY
ROOF RACK - MOUNTING KITS	
MU-X Mount to suit LS-T model only	IRRFEETMUX
• Will only fit vehicles with factory fitted roof bars.	
SEAT COVER	
Canvas Comfort - Front	ICSC040F
BREATHER KIT	
Universal Twin Manifold Filtered Breather Kit	IDIFFBRE

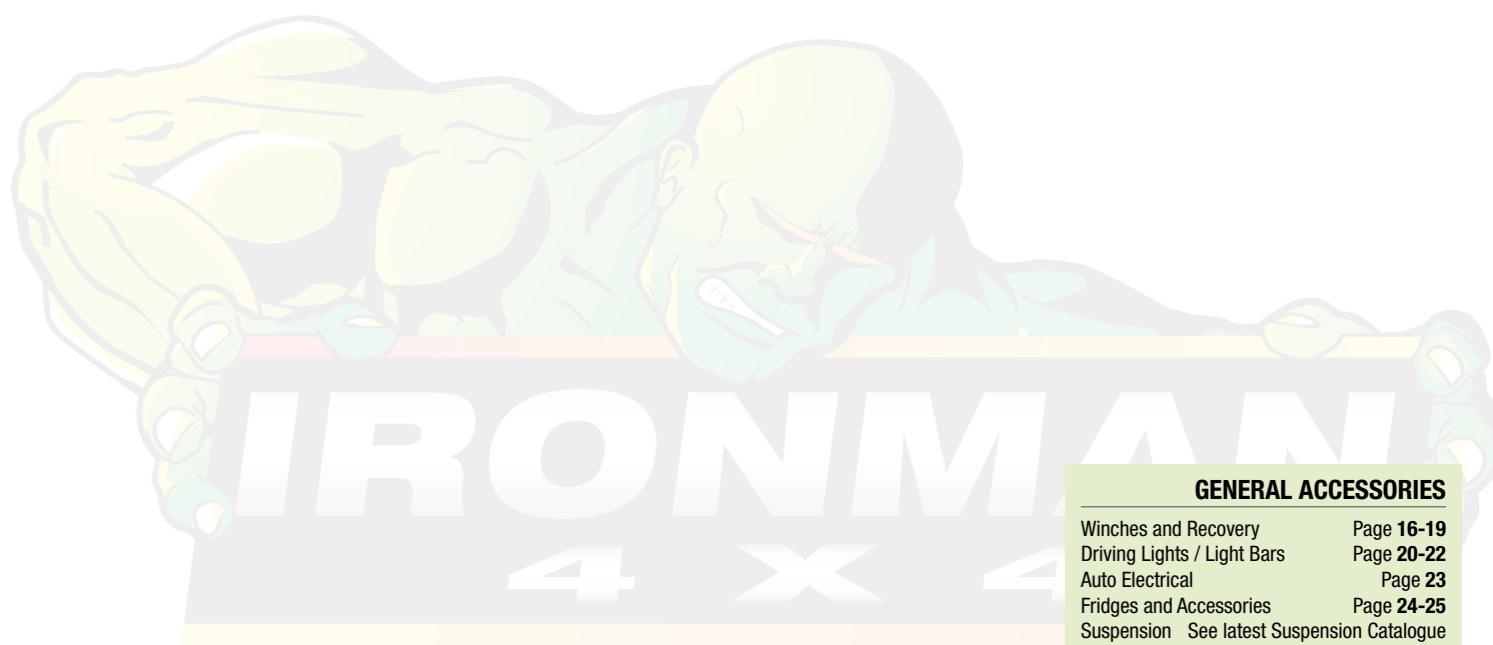

GENERAL ACCESSORIES

Winches and Recovery	Page 16-19
Driving Lights / Light Bars	Page 20-22
Auto Electrical	Page 23
Fridges and Accessories	Page 24-25
Suspension	See latest Suspension Catalogue

GRAND CHEROKEE

WK2 2013+



WRANGLER

JK 2007+



Accessory

Part No.

STEEL WINCH BULL BARS (AIR BAG COMPATIBLE) - Only fits Diesel Laredo without Quadra-lift Suspension

Deluxe Black Commercial
Polished Alloy

BBCD052
BBA052

BREATHER KIT

Universal Twin Manifold Filtered Breather Kit

IDIFFBRE

Accessory

Part No.

STEEL WINCH BULL BARS (AIR BAG COMPATIBLE) - Must use OE Fog Lights

Deluxe Black Commercial

BBCD035

BREATHER KIT

Universal Twin Manifold Filtered Breather Kit

IDIFFBRE

JEEP

JEEP

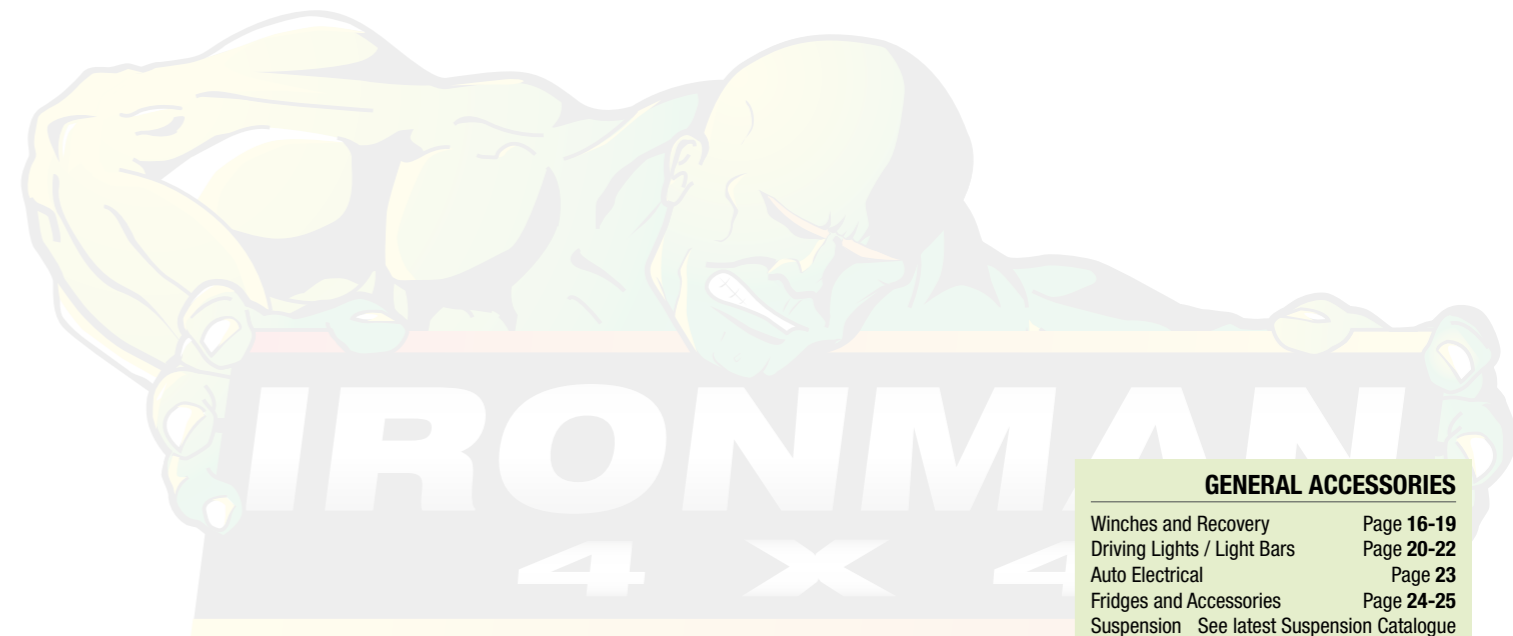

2007 to 2016



Series 2, 3 and 4

Accessory **Part No.** **Accessory** **Part No.**

STEEL WINCH BULL BARS - Non-Airbag models only

Black Commercial (Tube Style) **BBC023**

LOCKSAFE DRAWER SYSTEMS

Twin Drawers - 1000mm **ITD1000**

Single Drawer - 1000mm **ISD1000**

STEEL ROOF RACKS

Cage Style - 1.4m x 1.25m **IRRCAGE14**

Cage Style - 1.8m x 1.25m **IRRCAGE18**

Cage Style - 2.2m x 1.25m **IRRCAGE22**

Rooftop Tent Compatible - 1.8m x 1.25m **IRRTENT18**

Rooftop Tent Compatible - 2.2m x 1.25m **IRRTENT22**

Trade Style - 1.8m x 1.25m (Open end) **IRRTRADE18**

Trade Style - 2.2m x 1.25m (Open end) **IRRTRADE22**

ALLOY ROOF RACKS

Cage Style - 1.4m x 1.25m **IRRCAGE14-ALLOY**

Cage Style - 1.8m x 1.25m **IRRCAGE18-ALLOY**

Cage Style - 2.2m x 1.25m **IRRCAGE22-ALLOY**

Trade Style - 1.4m x 1.25m (Open end) **IRROPEN14-ALLOY**

Trade Style - 1.8m x 1.25m (Open end) **IRRTRADE18-ALLOY**

Trade Style - 2.2m x 1.25m (Open end) **IRRTRADE22-ALLOY**

ROOF RACK - MOUNTING KITS

Gutter Mount Feet - 210mm (8 Feet) **IRRFEET210**

BREATHER KIT

Universal Twin Manifold Filtered Breather Kit **IDIFFBRE**

LOCKSAFE DRAWER SYSTEMS - Fits Discovery 2 only

Twin Drawers - 900mm **ITD900**

Single Drawer - 900mm **ISD900**

UNDERBODY PROTECTION - Fits Discovery 3 and 4, and Range Rover Sport 2005 to 2013

Engine Bay and Transmission **IUP016K**

BREATHER KIT

Universal Twin Manifold Filtered Breather Kit **IDIFFBRE**

LAND ROVER

LAND ROVER

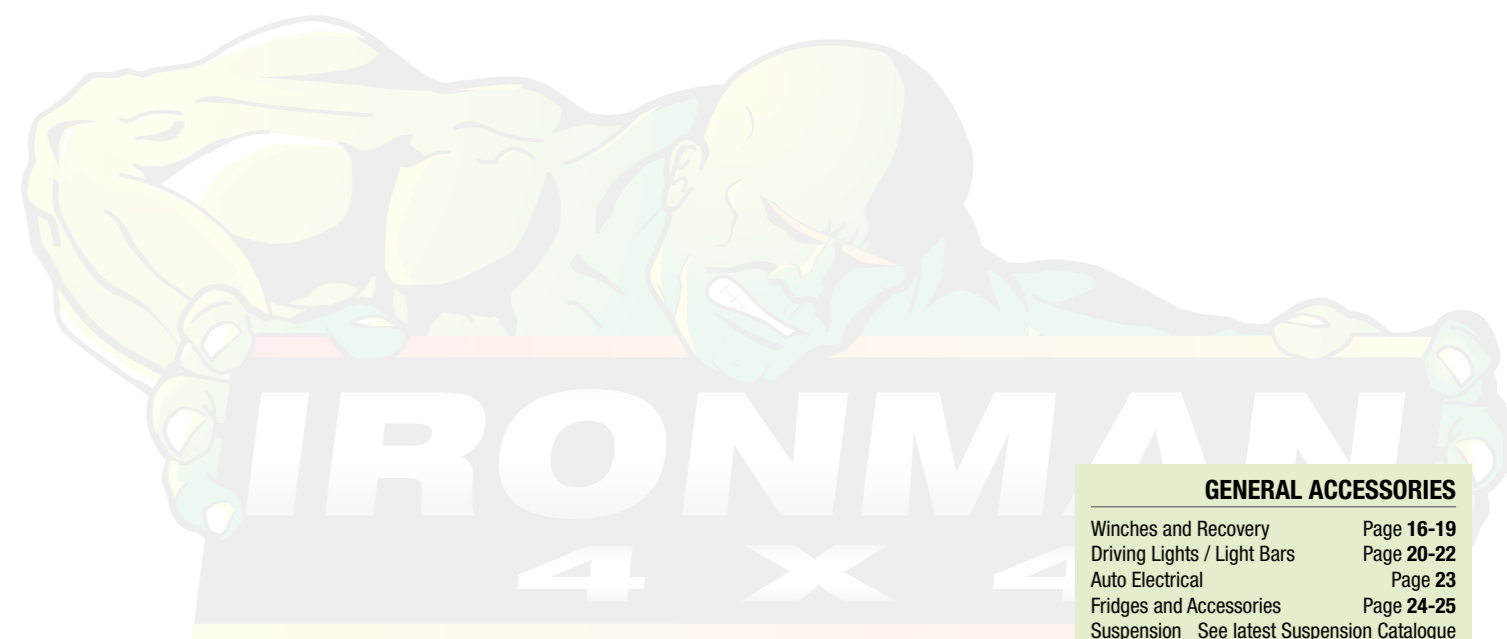

GENERAL ACCESSORIES

Winches and Recovery	Page 16-19
Driving Lights / Light Bars	Page 20-22
Auto Electrical	Page 23
Fridges and Accessories	Page 24-25
Suspension	See latest Suspension Catalogue

2012+ (Includes 2016 Facelift)



MAZDA

Accessory	Part No.
STEEL WINCH BULL BARS (AIR BAG COMPATIBLE)	
Black Commercial	BBC039
Deluxe Black Commercial	BBCD039
Protector	BBT039
• Can also be fitted to both 2WD and 4WD models.	
STEEL SIDE STEPS, SIDE STEPS AND RAILS (AIR BAG COMPATIBLE) - Fits Dual Cab models only	
Side Steps	SS039
Side Steps Rails	SSR039
TOWING	
Class 4 Towbar - Compatible with Factory Rear Step	TB038
Rear Protection Towbar - Full Rear Bumper Replacement	RTB038
Rear Protection Towbar Plates (Pair)	RTBPLATE001
Towbar Wiring Loom - Plug and Play	ITBL039
LOCKSAFE DRAWER SYSTEMS	
Twin Drawers - 1300mm	ITD1300
Single Drawer - 1300mm	ISD1300
Wing Kit - 1300mm*	ITDW037
*Designed to suit factory tubs, will not suit ute liner without modification	
BIGBORE EXHAUST SYSTEM	
BT50 3.2L Diesel - Does not suit DPF Model	IEXHAUST008
BT50 2.2L Diesel	IEXHAUST020
LONG RANGE FUEL TANK	
140L	TANK007
PREMIUM UNDERBODY PROTECTION	
Engine Bay and Transmission	UBP054
UNDERBODY PROTECTION	
Engine Bay and Transmission	IUP014K
Fuel Tank	IUP014F
• Fuel tank protection plates are not compatible with long range fuel tanks.	

Accessory	Part No.
CANOPY ABS PLASTIC (SIDE LIFT UP WINDOWS) - Fits 4x4 and 4x2 Dual Cab models	
	Pre-Primed CANOPY010-P
Cool White (AZW) CANOPY010-CW	Frozen White (7VT) CANOPY010-FW
Aurora Blue (39A) CANOPY010-AB	Black Mica (16W) CANOPY010-BM
Gunmetal Blue (39L) CANOPY010-GB	Metropolitan Grey (36C) CANOPY010-MG
Highlight Silver (18G) CANOPY010-S	Aluminium Metallic (38P) CANOPY010-AM
Chilli Orange (33J) CANOPY010-CO	Ingot Silver (WVR) CANOPY010-IS
Magnetic Grey (WVQ) CANOPY010-M	Shadow Black (WVS) CANOPY010-SB
True Red (A4A) CANOPY010-TR	Winning Blue (WVV) CANOPY010-WB
Jet Black Mica (41W) CANOPY018-B	Titanium Flash (42A) CANOPY018-TF
TUB STRENGTHENING BRACKET	
To suit ABS Plastic Canopy - (Must be fitted)	CANOPY010 BRACKET
DUAL CAB UTE LINER (COMPATIBLE WITH ABS CANOPY) - Fits 4x4 and 4x2 Dual Cab models	
<i>Superlock kit must be used if fitting Ironman 4x4 Canopy to Ute Liner</i>	
BT50 2012+	LINER012
Superlock Kit	SUPERLOCK
• Not compatible with hardtop lids and factory sports bars.	
SEAT COVER	
2012-2015 Canvas Comfort - Front	ICSC038F
2012-2015 Canvas Comfort - Rear	ICSC038R
2016+ Canvas Comfort - Front	ICSC054F
2016+ Canvas Comfort - Rear	ICSC055R
BREATHER KIT	
Universal Twin Manifold Filtered Breather Kit	IDIFFBRE

MAZDA

Listing continued on following page

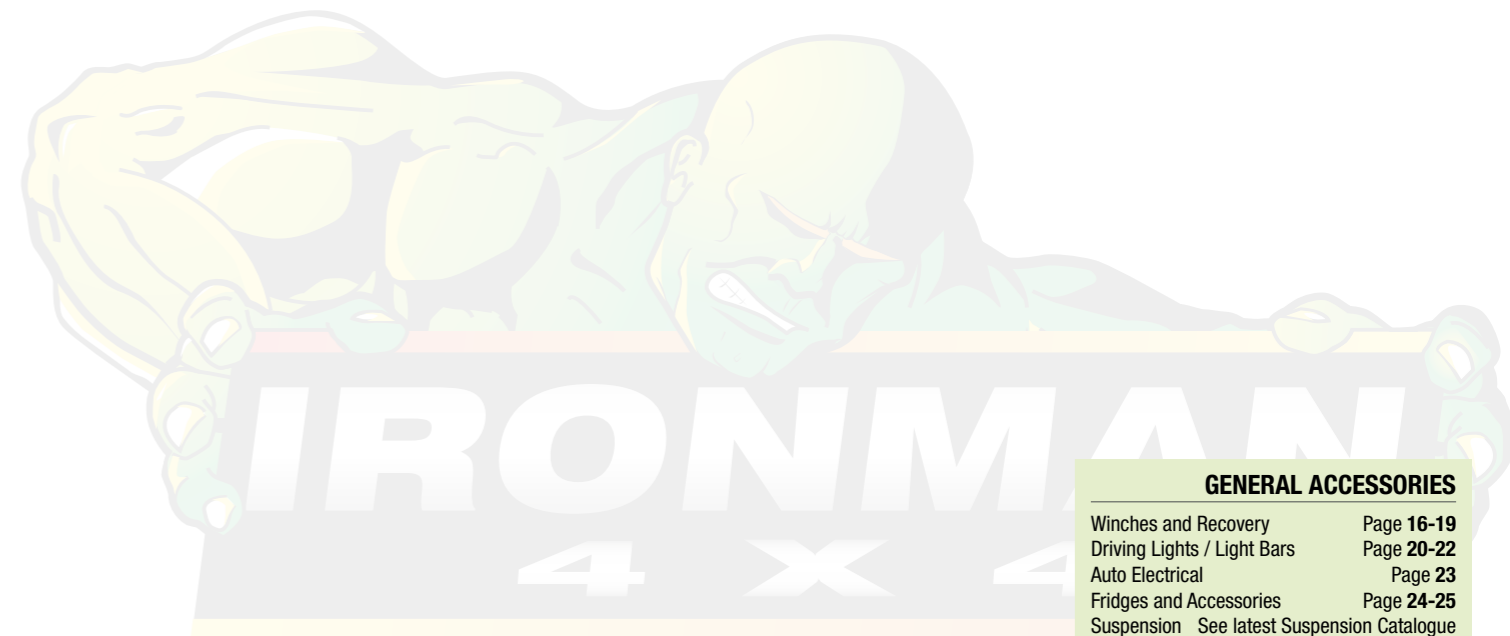

GENERAL ACCESSORIES	
Winches and Recovery	Page 16-19
Driving Lights / Light Bars	Page 20-22
Auto Electrical	Page 23
Fridges and Accessories	Page 24-25
Suspension	See latest Suspension Catalogue



Accessory	Part No.
STEEL WINCH BULL BARS (AIR BAG COMPATIBLE)	
Black Commercial	BBC024
Deluxe Black Commercial	BBCD024
Protector	BBT024
• Can also be fitted to both 2WD and 4WD models.	
STEEL SIDE STEPS, SIDE STEPS AND RAILS - Fits Dual Cab models only	
Side Steps	SS009
Side Steps and Rails	SSR007
LOCKSAFE DRAWER SYSTEMS - Fits Dual Cab and Extra Cab models	
Twin Drawers - 1300mm	ITD1300
Single Drawer - 1300mm	ISD1300
SNORKEL	
3.0L TDi Diesel	ISNORKEL024
BIGBORE EXHAUST SYSTEM - Diesel only	
BT50 (Automatic Transmission)	IEXHAUST014
BT50 (Manual Transmission)	IEXHAUST015
LONG RANGE FUEL TANK - Fits Dual Cab and Single Cab models only	
122L	TANK006
UNDERBODY PROTECTION	
Engine Bay and Transmission	IUP008K
CANOPY ABS PLASTIC (SIDE LIFT UP WINDOWS) - Fits 4x4 and 4x2 Dual Cab models	
Pre-Primed	CANOPY004-P
White (A2W)	CANOPY004-W
DUAL CAB UTE LINER (COMPATIBLE WITH ABS CANOPY) - Fits 4x4 and 4x2 Dual Cab models	
Superlock kit must be used if fitting Ironman 4x4 Canopy to Ute Liner	
BT50 2006 to 2012	LINER003
Superlock Kit	SUPERLOCK
• Not compatible with hardtop lids and factory sports bars.	
BREATHER KIT	
Universal Twin Manifold Filtered Breather Kit	IDIFFBRE

Accessory	Part No.
STEEL WINCH BULL BARS (AIR BAG COMPATIBLE) - Suits GLX and GLS models only	
Deluxe Black Commercial	BBCD059
Protector	BBT059
STEEL SIDE STEPS, SIDE STEPS AND RAILS (AIR BAG COMPATIBLE)	
Side Steps	SS059
LONG RANGE FUEL TANK - Diesel only	
125L Diesel	TANK004
SEAT COVER	
Canvas Comfort - Front	ICSC059F
Canvas Comfort - Rear	ICSC059R
BREATHER KIT	
Universal Twin Manifold Filtered Breather Kit	IDIFFBRE



GENERAL ACCESSORIES	
Winches and Recovery	Page 16-19
Driving Lights / Light Bars	Page 20-22
Auto Electrical	Page 23
Fridges and Accessories	Page 24-25
Suspension	See latest Suspension Catalogue

NW 2011 to NX



NM, NP, NS, NT 5/2000 to 2011

Accessory

Part No.

STEEL WINCH BULL BARS (AIR BAG COMPATIBLE) - Not suitable for vehicles with factory fitted headlight washers

Black Commercial	BBC045
Deluxe Black Commercial	BBCD045
Protector	BBT045

UNDERBODY PROTECTION (2000+)

Engine Bay and Transmission	IUP013K
-----------------------------	----------------

BREATHER KIT

Universal Twin Manifold Filtered Breather Kit	IDIFFBRE
---	-----------------

Accessory

Part No.

UNDERBODY PROTECTION (2000+)

Engine Bay and Transmission	IUP013K
-----------------------------	----------------

BREATHER KIT

Universal Twin Manifold Filtered Breather Kit	IDIFFBRE
---	-----------------

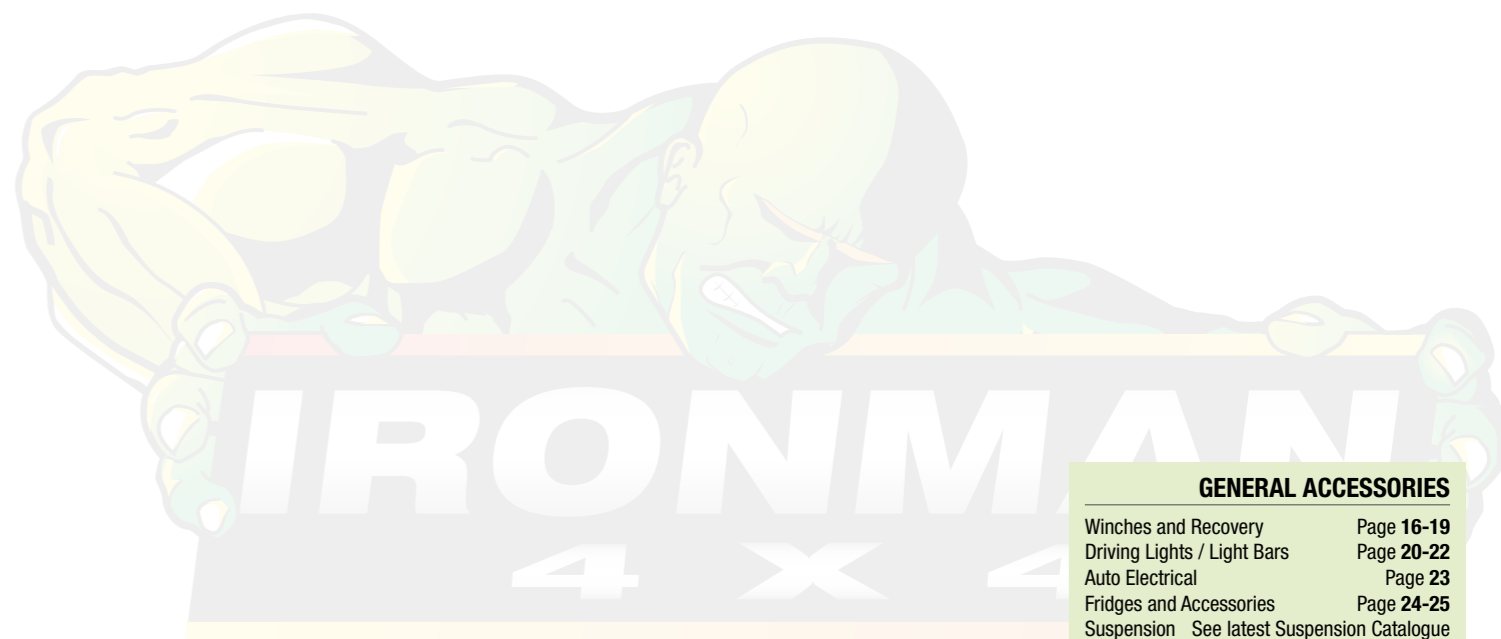

GENERAL ACCESSORIES

Winches and Recovery	Page 16-19
Driving Lights / Light Bars	Page 20-22
Auto Electrical	Page 23
Fridges and Accessories	Page 24-25
Suspension	See latest Suspension Catalogue

MQ 2015+



MN 2009 to 2015

Accessory	Part No.		
STEEL WINCH BULL BARS (AIR BAG COMPATIBLE) - Fits 4x4 and 4x2 models			
Black Commercial	BBC050		
Deluxe Black Commercial	BBCD050		
Protector	BBT050		
Polished Alloy	BBA050		
STEEL SIDE STEPS, SIDE STEPS AND RAILS - Fits Dual Cab models only			
Side Steps	SS050		
Side Rails	SS050 RAIL		
Side Steps and Rails	SSR050		
TOWING			
Class 4 Towbar - Compatible with Factory Rear Step	TB050		
Rear Protection Towbar - Full Rear Bumper Replacement	RTB050		
Rear Protection Towbar Plates (Pair)	RTBPLATE050		
Towbar Wiring Loom - Plug and Play	ITBL050		
LOCKSAFE DRAWER SYSTEMS - Fits Dual and Extra Cab			
Twin Drawers - 1300mm	ITD1300		
Single Drawer - 1300mm	ISD1300		
Wing Kit - 1300mm*	ITDW050		
<i>*Designed to suit factory tubs, will not suit ute liner without modification</i>			
SNORKEL			
Triton MQ 2015+	ISNORKEL050		
LONG RANGE FUEL TANK - Diesel only - Fits Dual Cab only			
125L Diesel	TANK004		
PREMIUM UNDERBODY PROTECTION			
Engine Bay and Transmission	UBP050		
UNDERBODY PROTECTION			
Engine Bay and Transmission - <i>Not compatible with bull bars</i>	IUP050K		
CANOPY SMOOTH FINISH FIBREGLASS (SIDE LIFT UP WINDOWS) - Fits 4x4 and 4x2 Dual Cab models			
Black Mica (X08)	CANFIBRE050-BM	Earth Green (F27)	CANFIBRE050-EG
Impulse Blue (D23)	CANFIBRE050-IB	Sterling Silver (U25)	CANFIBRE050-SS
Titanium Grey (V17)	CANFIBRE050-TG	White Solid (W32)	CANFIBRE050-WS
CANOPY ABS PLASTIC (SIDE LIFT UP WINDOWS) - Fits 4x4 and 4x2 Dual Cab models			
		Pre Primed	CANOPY014-P
Black Mica (X08)	CANOPY014-BM	Earth Green (F27)	CANOPY014-EG
Impulse Blue (D23)	CANOPY014-IB	Red Solid (R59)	CANOPY014-RS
Sterling Silver (U25)	CANOPY014-SS	Titanium Grey (V17)	CANOPY014-TG
		White Solid (W32)	CANOPY014-WS
DUAL CAB UTE LINER (COMPATIBLE WITH ABS CANOPY) - Fits 4x4 and 4x2 Dual Cab models			
<i>Superlock kit must be used if fitting Ironman 4x4 Canopy to Ute Liner</i>			
MQ Triton	LINER017		
Superlock Kit	SUPERLOCK		
<i>• Not compatible with hardtop lids and factory sports bars.</i>			
SEAT COVER			
Canvas Comfort - Front	ICSC050F		
Canvas Comfort - Rear	ICSC050R		
BREATHER KIT			
Universal Twin Manifold Filtered Breather Kit	IDIFFBRE		

Accessory	Part No.		
STEEL WINCH BULL BARS (AIR BAG COMPATIBLE)			
Black Commercial	BBC031		
Deluxe Black Commercial	BBCD031		
Protector	BBT031		
<i>• Can also be fitted to both 2WD and 4WD models.</i>			
STEEL SIDE STEPS, SIDE STEPS AND RAILS - Fits Dual Cab, Extra Cab and Single Cab			
Side Steps	SS031		
Side Steps and Rails	SSR031		
LOCKSAFE DRAWER SYSTEMS			
Twin Drawers - 1300mm	ITD1300		
Single Drawer - 1300mm	ISD1300		
Wing Kit - 1300mm*	ITDW032		
<i>*Designed to suit factory tubs, will not suit ute liner without modification</i>			
SNORKEL			
Triton	ISNORKEL020		
BIGBORE EXHAUST SYSTEM - Diesel only			
Triton MN (Automatic Transmission)	IEEXHAUST019		
Triton MN (Manual Transmission)	IEEXHAUST018		
LONG RANGE FUEL TANK - Fits Dual Cab only			
125L Diesel	TANK004		
125L Petrol	TANK005		
<i>• Modification required with factory rear diff-lock.</i>			
CANOPY ABS PLASTIC (SIDE LIFT UP WINDOWS) - Fits 4x4 and 4x2 Dual Cab models			
		Pre-Primed	CANOPY008-P
White (W32)	CANOPY008-W	Black Mica (X08)	CANOPY008-B
Blue Mica (T64)	CANOPY008-BM	Titanium Grey (A67)	CANOPY008-TG
Charcoal Grey (A02)	CANOPY008-CG	Ironbark (C06)	CANOPY008-IB
		Cool Silver (A66)	CANOPY008-S
DUAL CAB UTE LINER (COMPATIBLE WITH ABS CANOPY) - Fits 4x4 and 4x2 Dual Cab models			
<i>Superlock kit must be used if fitting Ironman 4x4 Canopy to Ute Liner</i>			
MN Triton	LINER008		
Superlock Kit	SUPERLOCK		
<i>• Not compatible with hardtop lids and factory sports bars.</i>			
SEAT COVER			
Canvas Comfort - Front	ICSC031F		
Canvas Comfort - Rear	ICSC031R		
<i>*Designed to suit factory tubs, will not suit ute liner without modification</i>			
BREATHER KIT			
Universal Twin Manifold Filtered Breather Kit	IDIFFBRE		

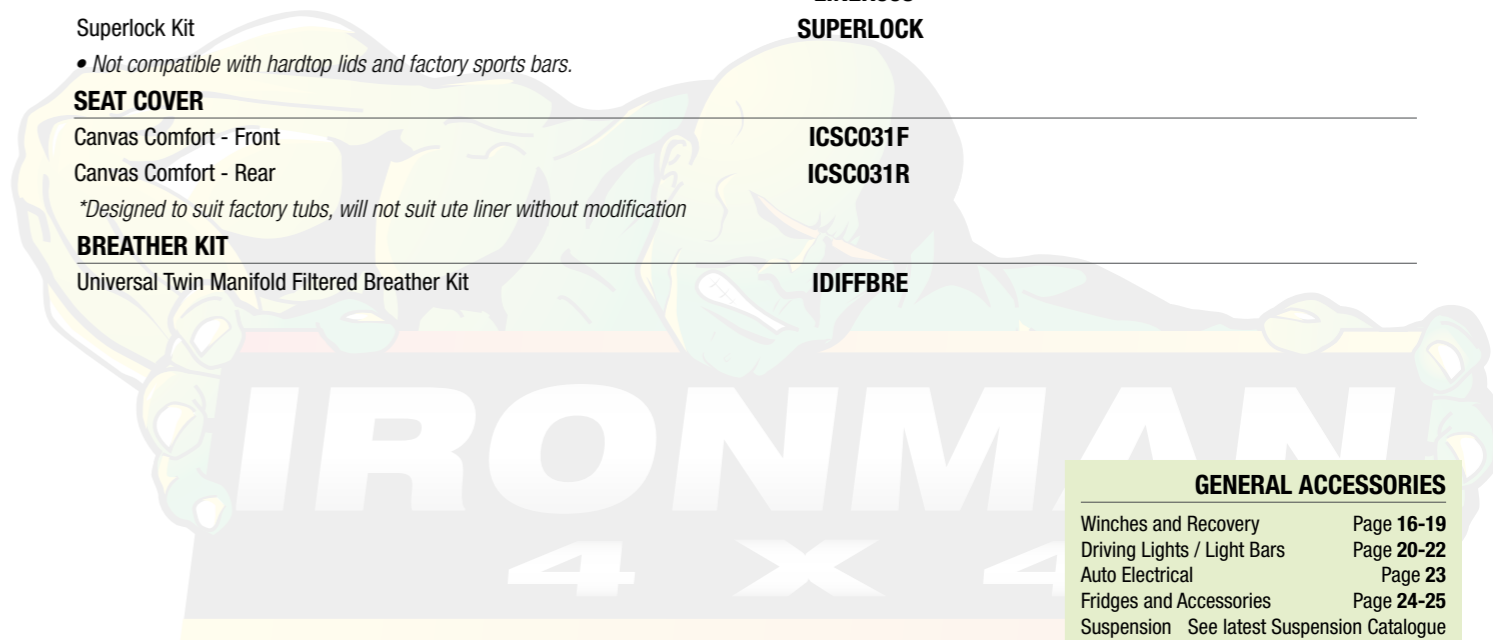

GENERAL ACCESSORIES

Winches and Recovery	Page 16-19
Driving Lights / Light Bars	Page 20-22
Auto Electrical	Page 23
Fridges and Accessories	Page 24-25
Suspension	See latest Suspension Catalogue



Accessory

Part No.

STEEL WINCH BULL BARS (AIR BAG COMPATIBLE)

Black Commercial	BBC016
Deluxe Black Commercial	BBCD016
Protector	BBT016

• Can also be fitted to both 2WD and 4WD models.

STEEL SIDE STEPS, SIDE STEPS AND RAILS - Fits Dual Cab and Extra Cab models only

Side Steps	SS004
Side Steps and Rails	SSR031

LOCKSAFE DRAWER SYSTEMS

Twin Drawers - 1300mm	ITD1300
Single Drawer - 1300mm	ISD1300
Wing Kit - 1300mm*	ITDW031

*Designed to suit factory tubs, will not suit ute liner without modification

SNORKEL

Triton	ISNORKEL020
--------	-------------

LONG RANGE FUEL TANK - Fits Dual Cab only

125L Diesel (Not compatible with factory diff-lock)	TANK004
125L Petrol (Not compatible with factory diff-lock)	TANK005

• Modification required with factory rear diff-lock.

UNDERBODY PROTECTION

Engine Bay and Transmission	IUP010K
Fuel Tank	IUP010F

• Fuel tank protection plates are not compatible with long range fuel tanks.

CANOPY ABS PLASTIC (SIDE LIFT UP WINDOWS) - Fits 4x4 and 4x2 Dual Cab models

Canopy - Round Profile **CANOPY005A**

DUAL CAB UTE LINER (COMPATIBLE WITH ABS CANOPY) - Fits 4x4 and 4x2 Dual Cab models
Superlock kit must be used if fitting Ironman 4x4 Canopy to Ute Liner

ML Triton 2006 to 2009	LINER004
Superlock Kit	SUPERLOCK

• Not compatible with hardtop lids and factory sports bars.

SEAT COVER

Canvas Comfort - Front	ICSC031F
Canvas Comfort - Rear	ICSC031R

BREATHER KIT

Universal Twin Manifold Filtered Breather Kit	IDIFFBRE
---	----------

Accessory

Part No.

STEEL WINCH BULL BARS (AIR BAG COMPATIBLE) - Fits 4x4 and 4x2 models

Black Commercial	BBC048
Deluxe Black Commercial	BBCD048
Protector	BBT048
Polished Alloy	BBA048

*Includes heavy duty front coil springs - Australia only

STEEL SIDE STEPS, SIDE STEPS AND RAILS - Fits Dual Cab models only

Side Steps	SS048
Side Rails	SS048 RAIL
Side Steps and Rails	SSR048

TOWING

Class 4 Towbar - Compatible with Factory Rear Step	TB048
Rear Protection Towbar - Full Rear Bumper Replacement	RTB048
Rear Protection Towbar Plates (Pair)	RTBPLATE048
Towbar Wiring Loom - Plug and Play	ITBL048

RECOVERY POINTS

Recovery Points Pair - 3500kg rating	IRP048
--------------------------------------	--------

LOCKSAFE DRAWER SYSTEMS - Fits Dual and Extra Cab

Twin Drawers - 1300mm	ITD1300
Single Drawer - 1300mm	ISD1300
Wing Kit - 1300mm*	ITDW048

*Designed to suit factory tubs, will not suit ute liner without modification

LONG RANGE FUEL TANK - Coil Spring model only

140L	TANK048
------	---------

PREMIUM UNDERBODY PROTECTION

Engine Bay and Transmission	UBP048
-----------------------------	--------

CANOPY SMOOTH FINISH FIBREGLASS (SIDE LIFT UP WINDOWS) - Fits 4x4 and 4x2 Dual Cab models

Polar White (QMI)	CANFIBRE048-PW	White Pearl (QXI)	CANFIBRE048-WP
Brilliant Silver (K23)	CANFIBRE048-BS	Cosmic Black (G42)	CANFIBRE048-CB
Hornet Gold (EAV)	CANFIBRE048-HG	Slate Grey (K21)	CANFIBRE048-SG

CANOPY ABS PLASTIC (SIDE LIFT UP WINDOWS) - Fits 4x4 and 4x2 Dual Cab models

Polar White (QMI)	CANOPY013-PW	White Pearl (QXI)	CANOPY013-WP
Brilliant Silver (K23)	CANOPY013-BS	Cosmic Black (G42)	CANOPY013-CB
Hornet Gold (EAV)	CANOPY013-HG	Slate Grey (K21)	CANOPY013-SG

DUAL CAB UTE LINER (COMPATIBLE WITH ABS CANOPY) - Fits 4x4 and 4x2 Dual Cab models

Superlock kit must be used if fitting Ironman 4x4 Canopy to Ute Liner

NP300 Navara	LINER015
Superlock Kit	SUPERLOCK

• Not compatible with hardtop lids and factory sports bars.

SEAT COVER

Canvas Comfort - Front	ICSC048F
Canvas Comfort - Rear	ICSC048R

BREATHER KIT

Universal Twin Manifold Filtered Breather Kit	IDIFFBRE
---	----------

GENERAL ACCESSORIES

Winches and Recovery	Page 16-19
Driving Lights / Light Bars	Page 20-22
Auto Electrical	Page 23
Fridges and Accessories	Page 24-25
Suspension	See latest Suspension Catalogue



Accessory	Part No.
STEEL WINCH BULL BARS (AIR BAG COMPATIBLE) - Recessed line in OE bumper bar and Thai built vehicles with smooth bumper	
Black Commercial	BBC012
Deluxe Black Commercial	BBCD012
Protector	BBT012
• Can also be fitted to both 2WD and 4WD models.	
STEEL WINCH BULL BARS (AIR BAG COMPATIBLE) - Smooth OE bumper bar except Thai built vehicles	
Black Commercial	BBC042
Deluxe Black Commercial	BBCD042
Protector	BBT042
• Can also be fitted to both 2WD and 4WD models.	
• STX Spain Built 2010+	
STEEL SIDE STEPS, SIDE STEPS AND RAILS - Thai Built Dual Cab model	
Side Steps	SS007
Side Steps and Rails	SSR003
STEEL SIDE STEPS, SIDE STEPS AND RAILS (AIR BAG COMPATIBLE) - Spain Built 2010+ Dual Cab model	
Side Steps	SS042
Side Steps and Rails	SSR042
RECOVERY POINTS	
Recovery Points Pair - 3500kg rating	IRP048
LOCKSAFE DRAWER SYSTEMS	
Twin Drawers - 1300mm	ITD1300
Single Drawer - 1300mm	ISD1300
Wing Kit - 1300mm (ST 2010+)*	ITDW028
Wing Kit - 1300mm (STX, 2006+ Spain built)*	ITDW029
*Designed to suit factory tubs, will not suit ute liner without modification	
SNORKEL	
D40 Navara 2005+	ISNORKEL019
• Not compatible with single cab model.	
BIGBORE EXHAUST SYSTEM	
Navara D40 550 1/2011+, V6 Turbo Diesel	IEXHAUST012
• Fits Automatic Transmission.	
LONG RANGE FUEL TANK - Diesel only	
Spain Built 145L Dual Cab	TANK003
Thai Built 145L Dual Cab (Includes adaptor kit)	TANK003T
UNDERBODY PROTECTION	
Engine Bay, Radiator* and Transmission	IUP007K
Fuel Tank	IUP007F
* IMPORTANT - Radiator plate ONLY suitable for Spain Built Vehicle. Does not fit vehicles with bull bar fitted.	
• Fuel tank protection plates are not compatible with long range fuel tanks.	

Listing continued on following page

Accessory	Part No.
CANOPY ABS PLASTIC (SIDE LIFT UP WINDOWS) - Fits 4x4 and 4x2 Dual Cab models	
Canopy - Square Profile	CANOPY003P
White (QMI)	CANOPY003-W
DUAL CAB UTE LINER (COMPATIBLE WITH ABS CANOPY) - Fits 4x4 and 4x2 Dual Cab models	
<i>Does not fit 2009+ Spain built STX models</i>	
<i>Superlock kit must be used if fitting Ironman 4x4 Canopy to Ute Liner</i>	
Navara D40 RX	LINER002
Superlock Kit	SUPERLOCK
• Not compatible with hardtop lids and factory sports bars.	
SEAT COVER	
Canvas Comfort - Front	ICSC042F
Canvas Comfort - Rear	ICSC042R
BREATHER KIT	
Universal Twin Manifold Filtered Breather Kit	IDIFFBRE

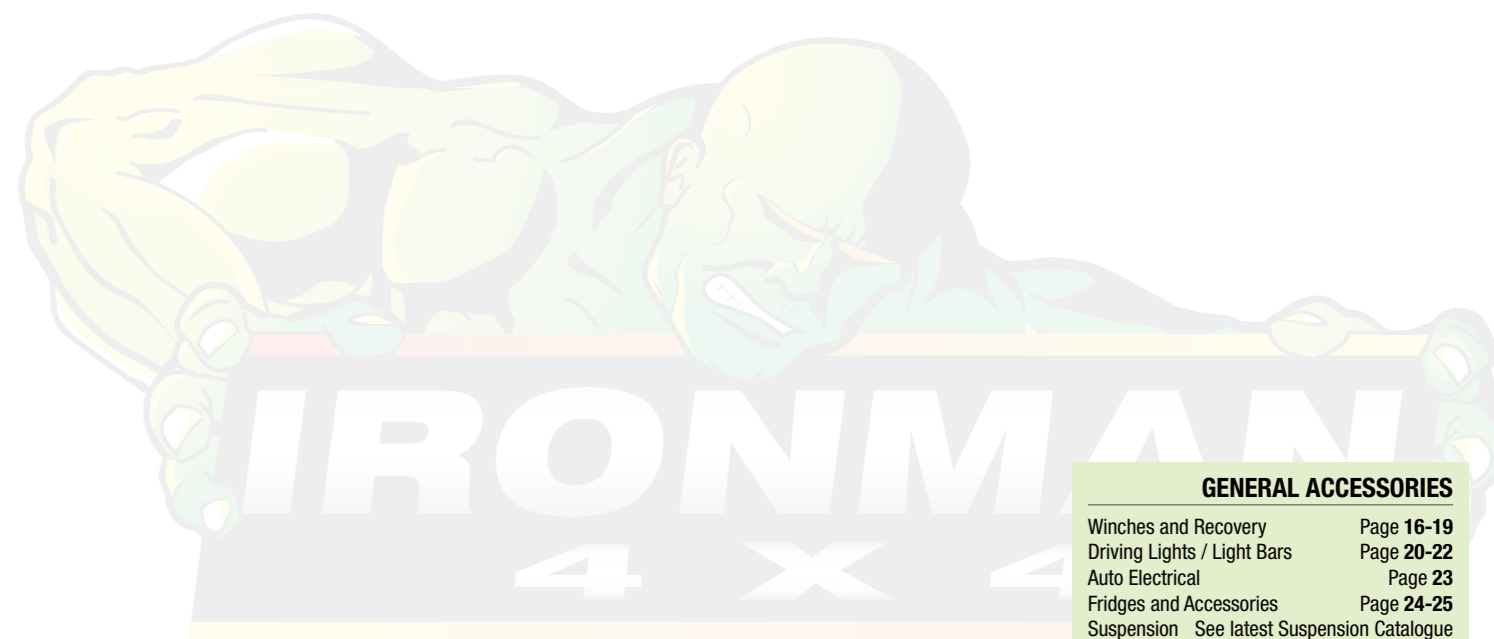

GENERAL ACCESSORIES

Winches and Recovery	Page 16-19
Driving Lights / Light Bars	Page 20-22
Auto Electrical	Page 23
Fridges and Accessories	Page 24-25
Suspension	See latest Suspension Catalogue

D22 2002+



R51 2005+



Accessory

Part No.

STEEL WINCH BULL BARS (AIR BAG COMPATIBLE)

Black Commercial	BBC013
Deluxe Black Commercial	BBCD013
Protector	BBT013

• Can also be fitted to both 2WD and 4WD models.

LOCKSAFE DRAWER SYSTEMS

Twin Drawer - 1300mm	ITD1300
Single Drawer - 1300mm	ISD1300
Wing Kit - 1300mm (2002 to 2007)*	ITDW025
Wing Kit - 1300mm (2007+)*	ITDW026

*Designed to suit factory tubs, will not suit ute liner without modification

BIGBORE EXHAUST SYSTEM

D22 Navara 2.5L Diesel Only	IEXHAUST011
-----------------------------	-------------

UNDERBODY PROTECTION - Diesel only

Engine Bay and Transmission	IUP006K
-----------------------------	---------

CANOPY ABS PLASTIC (SIDE LIFT UP WINDOWS) - Fits 4x4 and 4x2 Dual Cab models (Feb 2009 on)

Pre-Primed CANOPY007-P

DUAL CAB UTE LINER (COMPATIBLE WITH ABS CANOPY) - Fits 4x4 and 4x2 Dual Cab models Superlock kit must be used if fitting Ironman 4x4 Canopy to Ute Liner

D22 Navara 2008+	LINER006
Superlock Kit	SUPERLOCK

• Not compatible with hardtop lids and factory sports bars.

BREATHER KIT

Universal Twin Manifold Filtered Breather Kit	IDIFFBRE
---	----------

Accessory

Part No.

STEEL WINCH BULL BARS (AIR BAG COMPATIBLE) - Recessed line in OE bumper bar

Black Commercial	BBC012
Deluxe Black Commercial	BBCD012
Protector	BBT012

STEEL WINCH BULL BARS (AIR BAG COMPATIBLE) - Smooth OE bumper bar

Black Commercial	BBC042
Deluxe Black Commercial	BBCD042
Protector	BBT042

SNORKEL

R51 Pathfinder	ISNORKEL019
----------------	-------------

UNDERBODY PROTECTION

Engine	IUP007E
--------	---------

BREATHER KIT

Universal Twin Manifold Filtered Breather Kit	IDIFFBRE
---	----------

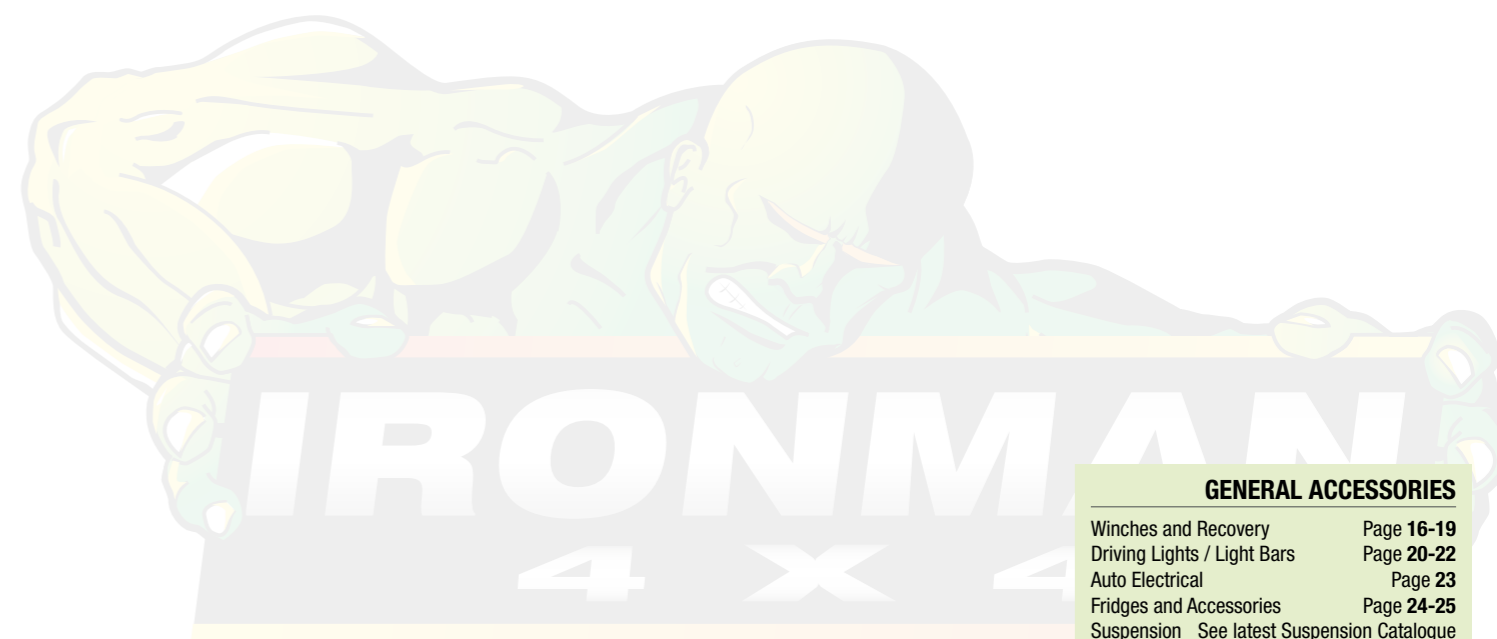

GENERAL ACCESSORIES

Winches and Recovery	Page 16-19
Driving Lights / Light Bars	Page 20-22
Auto Electrical	Page 23
Fridges and Accessories	Page 24-25
Suspension	See latest Suspension Catalogue

UNDERBODY UBP SERIES PROTECTION

THE PREMIUM UNDERBODY PROTECTION SOLUTION TO SAFEGUARD AGAINST OFF-ROAD DAMAGE FROM ROCKS, STUMPS AND GROUND STRIKE.

NEW

AUSTRALIAN
ENGINEERED
& DESIGNED



3 X MORE
AREA
COVERAGE

TEXTURED POWDER
COAT FINISH AND ANTI
CORROSION COATING

SERVICE INSPECTION HOLES

AIRFLOW VENTILATION

FABRICATED
4MM STEEL

INTEGRATED
FRAMEWORK

5 X IMPACT
RESISTANCE

DRAINAGE
OUTLETS

RECESSED
HARDWARE



Prices do not include freight or fitting and are subject to change without notice.



SAFER, STRONGER, SMARTER



Y62 2010+

PATROL

Accessory

Part No.

STEEL WINCH BULL BARS (AIR BAG COMPATIBLE)

Premium Commercial Deluxe - 60.3mm Tube

BBP062

BREATHER KIT

Universal Twin Manifold Filtered Breather Kit

IDIFFBRE

NISSAN

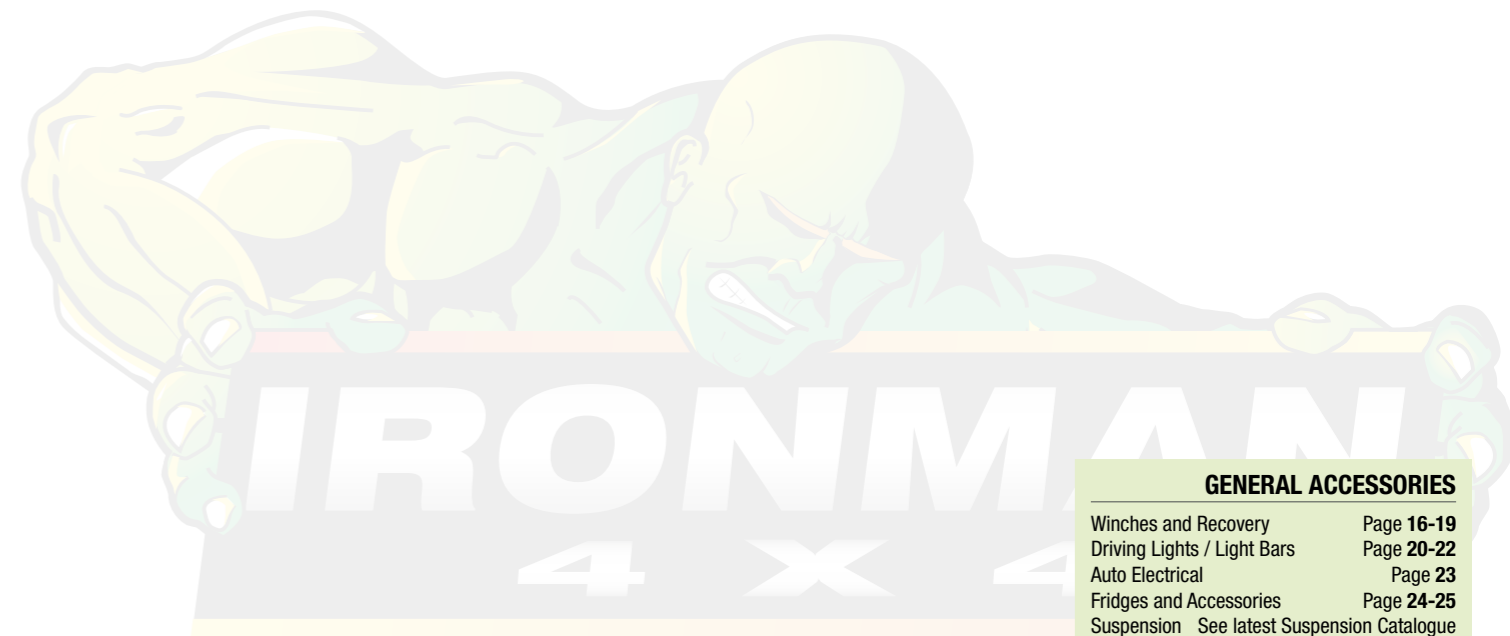

GENERAL ACCESSORIES

Winches and Recovery	Page 16-19
Driving Lights / Light Bars	Page 20-22
Auto Electrical	Page 23
Fridges and Accessories	Page 24-25
Suspension	See latest Suspension Catalogue



Accessory	Part No.
STEEL WINCH BULL BARS (AIR BAG COMPATIBLE)	
Deluxe Black Commercial (Coil Spring Only)	BBCD011
Protector (Coil Spring Only)	BBT011
Premium Commercial Deluxe - 60.3mm Tube	BBP011
STEEL SIDE STEPS, SIDE STEPS AND RAILS	
Side Steps	SS012
Side Steps and Rails	SSR012
Premium Side Steps and Rails - 60.3mm Tube	SSRP011
LOCKSAFE DRAWER SYSTEMS	
Twin Drawers - 1000mm	ITD1000
Single Drawer - 1000mm	ISD1000
Wing Kit - 1000mm (DX, ST, STI)*	ITDW011
SNORKEL	
GU Patrol Series 4	ISNORKEL013
BIGBORE EXHAUST SYSTEM	
GU Patrol 3L Turbo Diesel Wagon (CRD and Di)	IEXHAUST006
STEEL ROOF RACKS	
Cage Style - 1.4m x 1.25m	IRRCAGE14
Cage Style - 1.8m x 1.25m	IRRCAGE18
Cage Style - 2.2m x 1.25m	IRRCAGE22
Rooftop Tent Compatible - 1.8m x 1.25m	IRRTENT18
Rooftop Tent Compatible - 2.2m x 1.25m	IRRTENT22
Trade Style - 1.8m x 1.25m (Open end)	IRRTRADE18
Trade Style - 2.2m x 1.25m (Open end)	IRRTRADE22
ALLOY ROOF RACKS	
Cage Style - 1.4m x 1.25m	IRRCAGE14-ALLOY
Cage Style - 1.8m x 1.25m	IRRCAGE18-ALLOY
Cage Style - 2.2m x 1.25m	IRRCAGE22-ALLOY
Trade Style - 1.4m x 1.25m (Open end)	IRROPEN14-ALLOY
Trade Style - 1.8m x 1.25m (Open end)	IRRTRADE18-ALLOY
Trade Style - 2.2m x 1.25m (Open end)	IRRTRADE22-ALLOY
ROOF RACK - MOUNTING KITS	
Gutter Mount Feet - 100mm (8 Feet)	IRRFEET100
Gutter Mount Feet - 125mm (8 Feet)	IRRFEET125
UNDERBODY PROTECTION	
Radiator and Transmission • 3.0L and 4.8L only.	IUP015K
SEAT COVER	
Canvas Comfort - Front	ICSC011F
Canvas Comfort - Rear	ICSC011R
BREATHER KIT	
Universal Twin Manifold Filtered Breather Kit	IDIFFBRE

Accessory	Part No.
STEEL WINCH BULL BARS (AIR BAG COMPATIBLE)	
Deluxe Black Commercial (Coil Spring Only)	BBCD009
STEEL SIDE STEPS, SIDE STEPS AND RAILS	
Side Steps	SS012
Side Steps and Rails	SSR012
LOCKSAFE DRAWER SYSTEMS	
Twin Drawers - 1000mm	ITD1000
Single Drawer - 1000mm	ISD1000
Wing Kit - 1000mm (DX, ST, STI)*	ITDW011
SNORKEL	
GU Patrol Series 1, 2 and 3	ISNORKEL015
BIGBORE EXHAUST SYSTEM	
GU Patrol 3L Turbo Diesel Wagon	IEXHAUST006
STEEL ROOF RACKS	
Cage Style - 1.4m x 1.25m	IRRCAGE14
Cage Style - 1.8m x 1.25m	IRRCAGE18
Cage Style - 2.2m x 1.25m	IRRCAGE22
Rooftop Tent Compatible - 1.8m x 1.25m	IRRTENT18
Rooftop Tent Compatible - 2.2m x 1.25m	IRRTENT22
Trade Style - 1.8m x 1.25m (Open end)	IRRTRADE18
Trade Style - 2.2m x 1.25m (Open end)	IRRTRADE22
ALLOY ROOF RACKS	
Cage Style - 1.4m x 1.25m	IRRCAGE14-ALLOY
Cage Style - 1.8m x 1.25m	IRRCAGE18-ALLOY
Cage Style - 2.2m x 1.25m	IRRCAGE22-ALLOY
Trade Style - 1.4m x 1.25m (Open end)	IRROPEN14-ALLOY
Trade Style - 1.8m x 1.25m (Open end)	IRRTRADE18-ALLOY
Trade Style - 2.2m x 1.25m (Open end)	IRRTRADE22-ALLOY
ROOF RACK - MOUNTING KITS	
Gutter Mount Feet - 100mm (8 Feet)	IRRFEET100
Gutter Mount Feet - 125mm (8 Feet)	IRRFEET125
UNDERBODY PROTECTION	
Radiator and Transmission • 3.0L and 4.8L only.	IUP015K
BREATHER KIT	
Universal Twin Manifold Filtered Breather Kit	IDIFFBRE

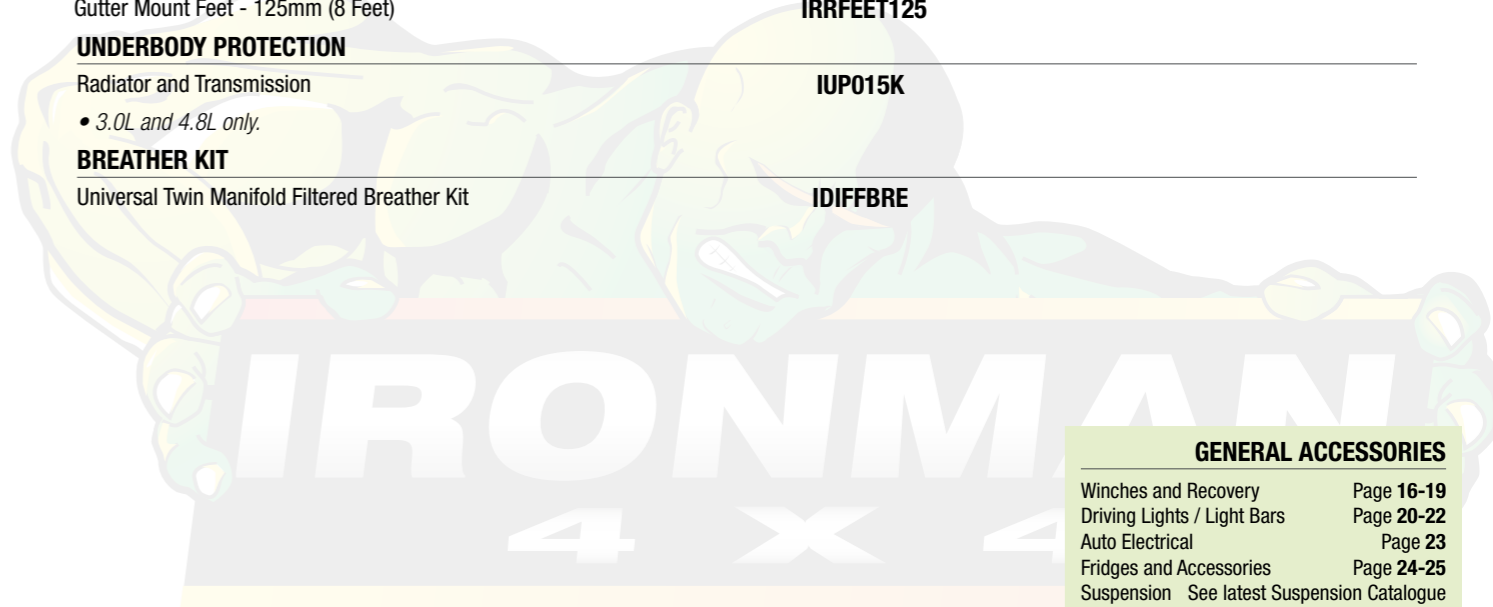

GENERAL ACCESSORIES

Winches and Recovery	Page 16-19
Driving Lights / Light Bars	Page 20-22
Auto Electrical	Page 23
Fridges and Accessories	Page 24-25
Suspension	See latest Suspension Catalogue



Accessory

Part No.

STEEL WINCH BULL BARS

Black Commercial	BBC010
Deluxe Black Commercial	BBCD010

LOCKSAFE DRAWER SYSTEMS

Twin Drawers - 1000mm	ITD1000
Single Drawer - 1000mm	ISD1000

SNORKEL

All Models Except 2.8L Diesel	ISNORKEL011
-------------------------------	--------------------

STEEL ROOF RACKS

Cage Style - 1.4m x 1.25m	IRRCAGE14
Cage Style - 1.8m x 1.25m	IRRCAGE18
Cage Style - 2.2m x 1.25m	IRRCAGE22
Rooftop Tent Compatible - 1.8m x 1.25m	IRRTENT18
Rooftop Tent Compatible - 2.2m x 1.25m	IRRTENT22
Trade Style - 1.8m x 1.25m (Open end)	IRRTRADE18
Trade Style - 2.2m x 1.25m (Open end)	IRRTRADE22

ALLOY ROOF RACKS

Cage Style - 1.4m x 1.25m	IRRCAGE14-ALLOY
Cage Style - 1.8m x 1.25m	IRRCAGE18-ALLOY
Cage Style - 2.2m x 1.25m	IRRCAGE22-ALLOY
Trade Style - 1.4m x 1.25m (Open end)	IRROPEN14-ALLOY
Trade Style - 1.8m x 1.25m (Open end)	IRRTRADE18-ALLOY
Trade Style - 2.2m x 1.25m (Open end)	IRRTRADE22-ALLOY

ROOF RACK - MOUNTING KITS

Gutter Mount Feet - 125mm (8 Feet - Does not fit high roof model)	IRRFEET125
Gutter Mount Feet - 210mm (8 Feet - Fits high roof model)	IRRFEET210

BREATHER KIT

Universal Twin Manifold Filtered Breather Kit	IDIFFBRE
---	-----------------

Accessory

Part No.

STEEL WINCH BULL BARS (AIR BAG COMPATIBLE) - Not Compatible with V6 model

Black Commercial	BBC046
Deluxe Black Commercial	BBCD046
Protector	BBT046

UNDERBODY PROTECTION

Engine Bay and Transmission	IUP011K
-----------------------------	----------------

BREATHER KIT

Universal Twin Manifold Filtered Breather Kit	IDIFFBRE
---	-----------------

NISSAN

SUZUKI

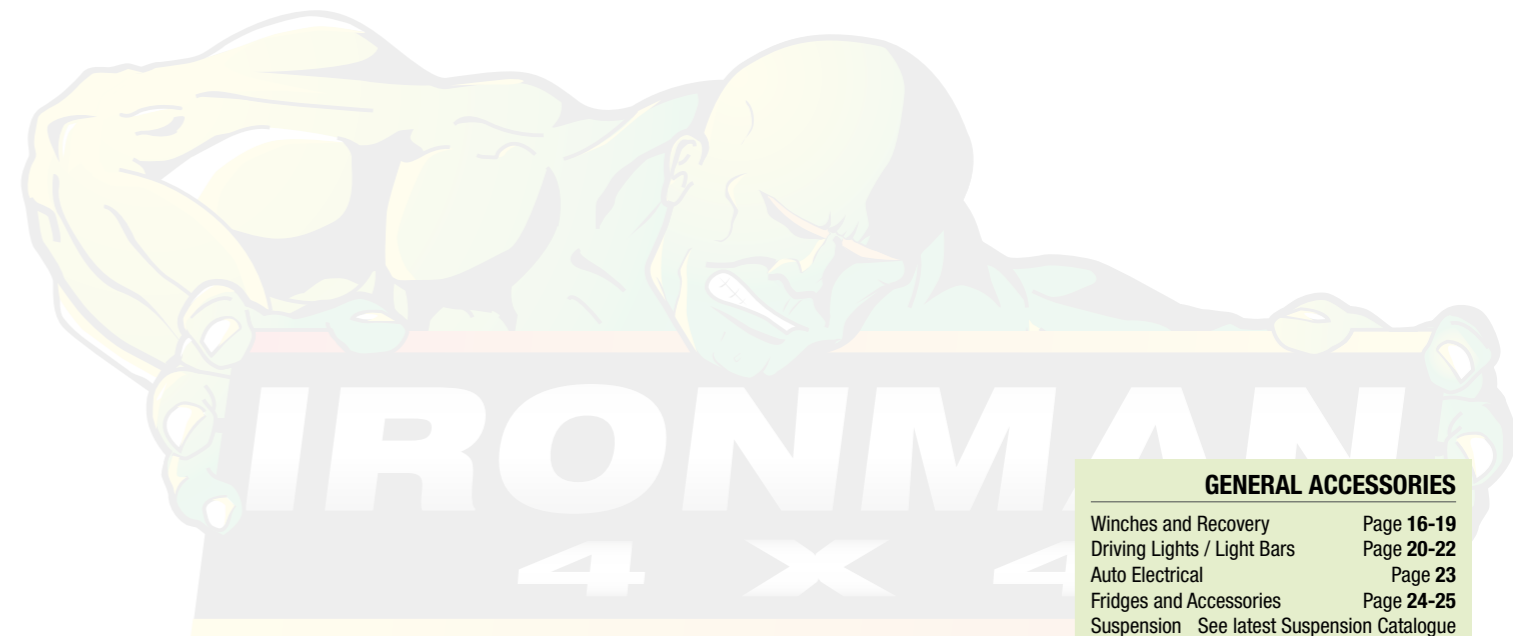

GENERAL ACCESSORIES

Winches and Recovery	Page 16-19
Driving Lights / Light Bars	Page 20-22
Auto Electrical	Page 23
Fridges and Accessories	Page 24-25
Suspension	See latest Suspension Catalogue

JIMNY

2012+



2007+

FJ CRUISER

Accessory

Part No.

STEEL WINCH BULL BARS

Deluxe Black Commercial

BBCD063

BREATHER KIT

Universal Twin Manifold Filtered Breather Kit

IDIFFBRE

Accessory

Part No.

STEEL WINCH BULL BARS (AIR BAG COMPATIBLE)

Deluxe Black Commercial

BBCD037

Protector

BBT037

UNDERBODY PROTECTION

Engine Bay and Transmission

IUP003K

BREATHER KIT

Universal Twin Manifold Filtered Breather Kit

IDIFFBRE

SUZUKI

TOYOTA

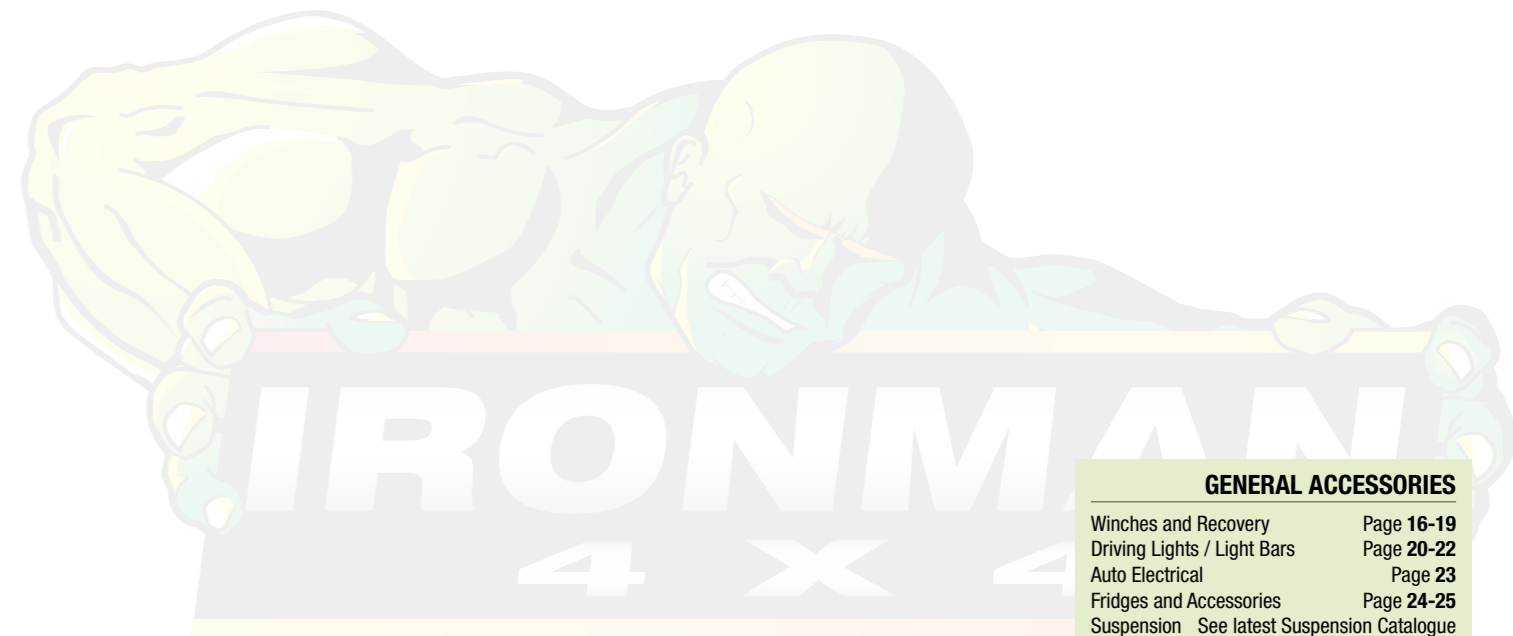

GENERAL ACCESSORIES

Winches and Recovery	Page 16-19
Driving Lights / Light Bars	Page 20-22
Auto Electrical	Page 23
Fridges and Accessories	Page 24-25
Suspension	See latest Suspension Catalogue



Accessory	Part No.
STEEL WINCH BULL BARS (AIR BAG COMPATIBLE) - Fits wide body models only	
<i>Hi-Rider - 4x2 SR & SR5 / Dual Cab 4x4 - Workmate, SR & SR5 / Extra Cab 4x4 - Workmate, SR & SR5</i>	
Black Commercial	BBC051
Deluxe Black Commercial	BBCD051
Protector	BBT051
Polished Alloy	BBA051
STEEL SIDE STEPS, SIDE STEPS AND RAILS - Fits Dual Cab models only	
Side Steps	SS051
Side Rails	SS051 RAIL
Side Steps and Rails	SSR051
TOWING	
Class 4 Towbar - Compatible with Factory Rear Step	TB051
Rear Protection Towbar - Full Rear Bumper Replacement	RTB051
Rear Protection Towbar Plates (Pair)	RTBPLATE001
Towbar Wiring Loom - Plug and Play	ITBL051
RECOVERY POINTS	
Recovery Points Pair - 5000kg rating	IRP051
LOCKSAFE DRAWER SYSTEMS - Fits Dual and Extra Cab	
Twin Drawers - 1300mm	ITD1300
Single Drawer - 1300mm	ISD1300
Wing Kit - 1300mm*	ITDW051
<i>*Designed to suit factory tubs, will not suit ute liner without modification</i>	
SNORKEL	
2.8L Turbo Diesel	ISNORKEL051
PREMIUM UNDERBODY PROTECTION	
Engine Bay and Transmission	UBP051
CANOPY SMOOTH FINISH FIBREGLASS (SIDE LIFT UP WINDOWS) - Fits 4x4 and 4x2 Dual Cab models	
Super White (040) CANFIBRE051-SW	Attitude Black (218) CANFIBRE051-AB
Silver Metallic (1D6) CANFIBRE051-SM	Dark Grey (1G3) CANFIBRE051-DG
CANOPY ABS PLASTIC (SIDE LIFT UP WINDOWS) - Fits A Deck - 4x4 and 4x2 Dual Cab models only	
	Pre-Primed CANOPY015-P
Super White (040) CANOPY015-SW	Attitude Black (218) CANOPY015-AB
Silver Metallic (1D6) CANOPY015-SM	Dark Grey (1G3) CANOPY015-DG
	Blue Metallic (8X2) CANOPY015-BM
	Super White (040) CANOPY017-SW
J DECK	
DUAL CAB UTE LINER (COMPATIBLE WITH ABS CANOPY) - Fits 4x4 and 4x2 Dual Cab models	
<i>Superlock kit must be used if fitting Ironman 4x4 Canopy to Ute Liner</i>	
A Deck	LINER018
J Deck (Superlock Kit Not Applicable)*	LINER019
Superlock Kit	SUPERLOCK
<i>* Not compatible with hardtop lids and factory sports bars</i>	
SEAT COVER	
Canvas Comfort - Front	ICSC051F
Canvas Comfort - Rear	ICSC051R
BREATHER KIT	
Universal Twin Manifold Filtered Breather Kit	IDIFFBRE

Accessory	Part No.
STEEL WINCH BULL BARS (AIR BAG COMPATIBLE) - Fits 4x4 and 4x2 models	
Black Commercial	BBC033
Deluxe Black Commercial	BBCD033
Protector	BBT033
STEEL SIDE STEPS, SIDE STEPS AND RAILS (AIR BAG COMPATIBLE) - Fits Dual Cab models only	
Side Steps	SS033
Side Steps and Rails	SSR033
LOCKSAFE DRAWER SYSTEMS	
Twin Drawers - 1300mm	ITD1300
Single Drawer - 1300mm	ISD1300
Wing Kit - 1300mm*	ITDW024
<i>*Designed to suit factory tubs, will not suit ute liner without modification</i>	
SNORKEL	
3L D4D TDi / 4L Petrol V6	ISNORKEL001
BIGBORE EXHAUST SYSTEM	
3L D4D TDi	IEEXHAUST005
LONG RANGE FUEL TANK - Diesel and Petrol 4WD only	
145L	TANK002
UNDERBODY PROTECTION	
Engine Bay and Transmission	IUP001K
CANOPY ABS PLASTIC (SIDE LIFT UP WINDOWS) - Fits 4x4 and 4x2 Dual Cab models	
A DECK	
	Pre-Primed - A Deck CANOPY001-P
Black (209) CANOPY001-B	Super White (040) CANOPY001-SW
J DECK	
	Pre-Primed - J Deck CANOPY002-P
	Round Profile - J Deck CANOPY002A
	Super White (040) CANOPY002-SW
DUAL CAB UTE LINER (COMPATIBLE WITH ABS CANOPY) - Fits 4x4 and 4x2 Dual Cab models	
<i>Superlock kit must be used if fitting Ironman 4x4 Canopy to Ute Liner</i>	
A Deck	LINER011
J Deck (Superlock Kit Not Applicable)*	LINER001-J
Superlock Kit	SUPERLOCK
<i>* Not compatible with hardtop lids and factory sports bars</i>	
SEAT COVER	
Canvas Comfort - Front	ICSC033F
Canvas Comfort - Rear	ICSC033R
BREATHER KIT	
Universal Twin Manifold Filtered Breather Kit	IDIFFBRE

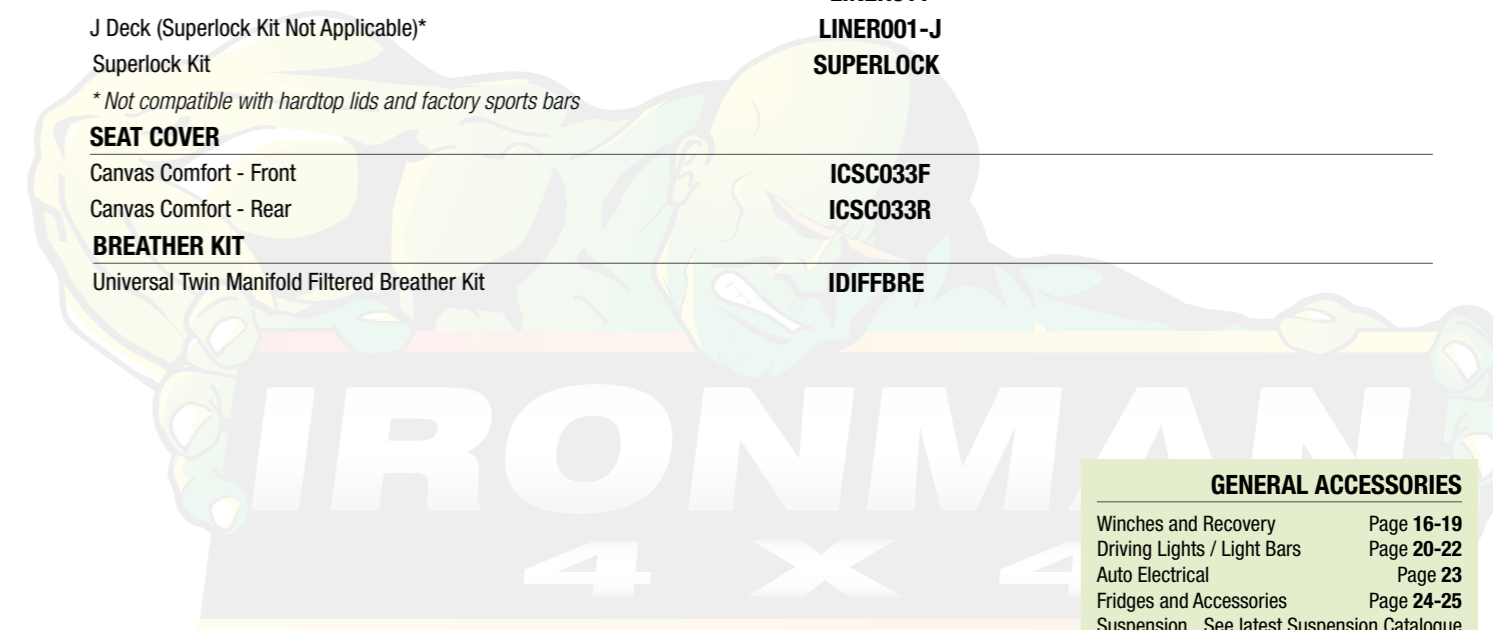

GENERAL ACCESSORIES

Winches and Recovery	Page 16-19
Driving Lights / Light Bars	Page 20-22
Auto Electrical	Page 23
Fridges and Accessories	Page 24-25
Suspension	See latest Suspension Catalogue



Accessory	Part No.
STEEL WINCH BULL BARS (AIR BAG COMPATIBLE) - Fits 4x4 and 4x2 models	
Black Commercial	BBC002
Deluxe Black Commercial	BBCD002
Protector	BBT002
STEEL SIDE STEPS, SIDE STEPS AND RAILS (AIR BAG COMPATIBLE) - Fits Dual Cab models only	
Side Steps	SS033
Side Steps and Rails	SSR033
LOCKSAFE DRAWER SYSTEMS	
Twin Drawers - 1300mm	ITD1300
Single Drawer - 1300mm	ISD1300
Wing Kit - 1300mm *	ITDW024
<i>*Designed to suit factory tubs, will not suit ute liner without modification</i>	
SNORKEL	
3L D4D TDi / 4L Petrol V6	ISNORKEL001
BIGBORE EXHAUST SYSTEM	
3L D4D TDi	IEXHAUST005
LONG RANGE FUEL TANK - Diesel and Petrol 4WD only	
145L	TANK002
UNDERBODY PROTECTION	
Engine Bay and Transmission	IUP001K
CANOPY ABS PLASTIC (SIDE LIFT UP WINDOWS) - Fits 4x4 and 4x2 Dual Cab models	
A DECK	
	Pre-Primed - A Deck CANOPY001-P
Black (209) CANOPY001-B	Super White (040) CANOPY001-SW
J DECK	
	Pre-Primed - J Deck CANOPY002-P
	Round Profile - J Deck CANOPY002A
	Super White (040) CANOPY002-SW
DUAL CAB UTE LINER (COMPATIBLE WITH ABS CANOPY) - Fits 4x4 and 4x2 Dual Cab models	
<i>Superlock kit must be used if fitting Ironman 4x4 Canopy to Ute Liner</i>	
A Deck	LINER001
A Deck	LINER011
J Deck (Superlock Kit Not Applicable)*	LINER001-J
Superlock Kit	SUPERLOCK
<i>* Not compatible with hardtop lids and factory sports bars</i>	
SEAT COVER	
Canvas Comfort - Front	ICSC033F
Canvas Comfort - Rear	ICSC033R
BREATHER KIT	
Universal Twin Manifold Filtered Breather Kit	IDIFFBRE

Accessory	Part No.
STEEL WINCH BULL BARS (AIR BAG COMPATIBLE) - 2001 to 2004	
Black Commercial	BBC001
Deluxe Black Commercial	BBCD001
STEEL SIDE STEPS (AIR BAG COMPATIBLE) - Fits Dual Cab models only	
Side Steps	SS005
LOCKSAFE DRAWER SYSTEMS	
Twin Drawers - 1300mm	ITD1300
Single Drawer - 1300mm	ISD1300
Wing Kit - 1300mm (SR-SR5)*	ITDW023
<i>*Designed to suit factory tubs, will not suit ute liner without modification</i>	
BREATHER KIT	
Universal Twin Manifold Filtered Breather Kit	IDIFFBRE

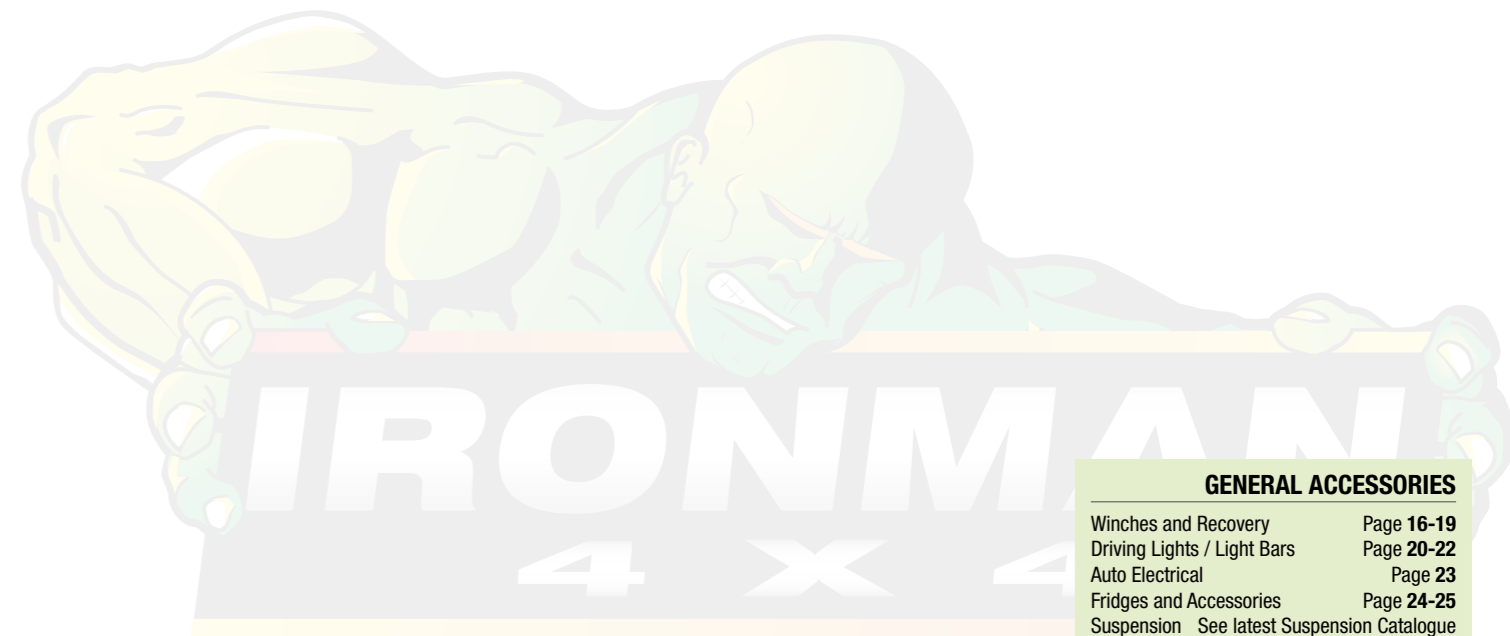

GENERAL ACCESSORIES	
Winches and Recovery	Page 16-19
Driving Lights / Light Bars	Page 20-22
Auto Electrical	Page 23
Fridges and Accessories	Page 24-25
Suspension	See latest Suspension Catalogue

2015+



200 Series (Facelift MkII) 10/2015+

Accessory

Part No.

STEEL WINCH BULL BARS (AIR BAG COMPATIBLE) - Fits 4x4 and 4x2 models

Deluxe Black Commercial	BBCD053
Protector	BBT053

STEEL SIDE STEPS, SIDE STEPS AND RAILS

Side Steps	SS053
Side Rails	SS053 RAIL
Side Steps and Rails	SSR053

RECOVERY POINTS

Recovery Points Pair - 5000kg rating	IRP051
--------------------------------------	--------

PREMIUM UNDERBODY PROTECTION

Engine Bay and Transmission	UBP051
-----------------------------	--------

SEAT COVER

Canvas Comfort - Front	ICSC053F
Canvas Comfort - Rear	ICSC053R

BREATHER KIT

Universal Twin Manifold Filtered Breather Kit	IDIFFBRE
---	----------

Accessory

Part No.

STEEL WINCH BULL BARS (AIR BAG COMPATIBLE) - Powdercoated Grey (1g3 Graphite)

GX AND GLX

Protector	BBT056
Premium Commercial Deluxe - 60.3mm Tube	BBP056
Polished Alloy	BBA056

STEEL WINCH BULL BARS (AIR BAG COMPATIBLE) - Powdercoated Grey (1g3 Graphite)

SAHARA VX

Protector	BBT056-VX
Premium Commercial Deluxe - 60.3mm Tube	BBP056-VX
Polished Alloy	BBA056-VX

STEEL SIDE STEPS, SIDE STEPS AND RAILS

Premium Side Steps - 60.3mm Tube	SS056
Premium Side Rails - 60.3mm Tube	SS056 RAIL
Premium Side Steps and Rails - 60.3mm Tube	SSR056

RECOVERY POINTS

Recovery Points Pair - 5000kg rating	IRP200
--------------------------------------	--------

SNORKEL

Landcruiser 200 Series	ISNORKEL056
------------------------	-------------

LOCKSAFE DRAWER SYSTEMS

Twin Drawers - 1000mm	ITD1000
Single Drawer - 1000mm	ISD1000
Wing Kit - 1000mm (May impede access to rear 240V outlet)	ITDW020

STEEL ROOF RACKS

Cage Style - 1.8m x 1.25m	IRRCAGE18
Rooftop Tent Compatible - 1.8m x 1.25m	IRRTENT18
Trade Style - 1.8m x 1.25m (Open end)	IRRTRADE18

ALLOY ROOF RACKS

Cage Style - 1.8m x 1.25m	IRRCAGE18-ALLOY
Trade Style - 1.8m x 1.25m (Open end)	IRRTRADE18-ALLOY

ROOF RACK - MOUNTING KITS

Landcruiser 200 Mount Feet - 200mm (8 Feet)	IRRFEETLC200
---	--------------

UNDERBODY PROTECTION

Engine Bay	IUP004E
------------	---------

SEAT COVER

Canvas Comfort - Front	ICSC043F
Canvas Comfort - Rear	ICSC043R

BREATHER KIT

Universal Twin Manifold Filtered Breather Kit	IDIFFBRE
---	----------

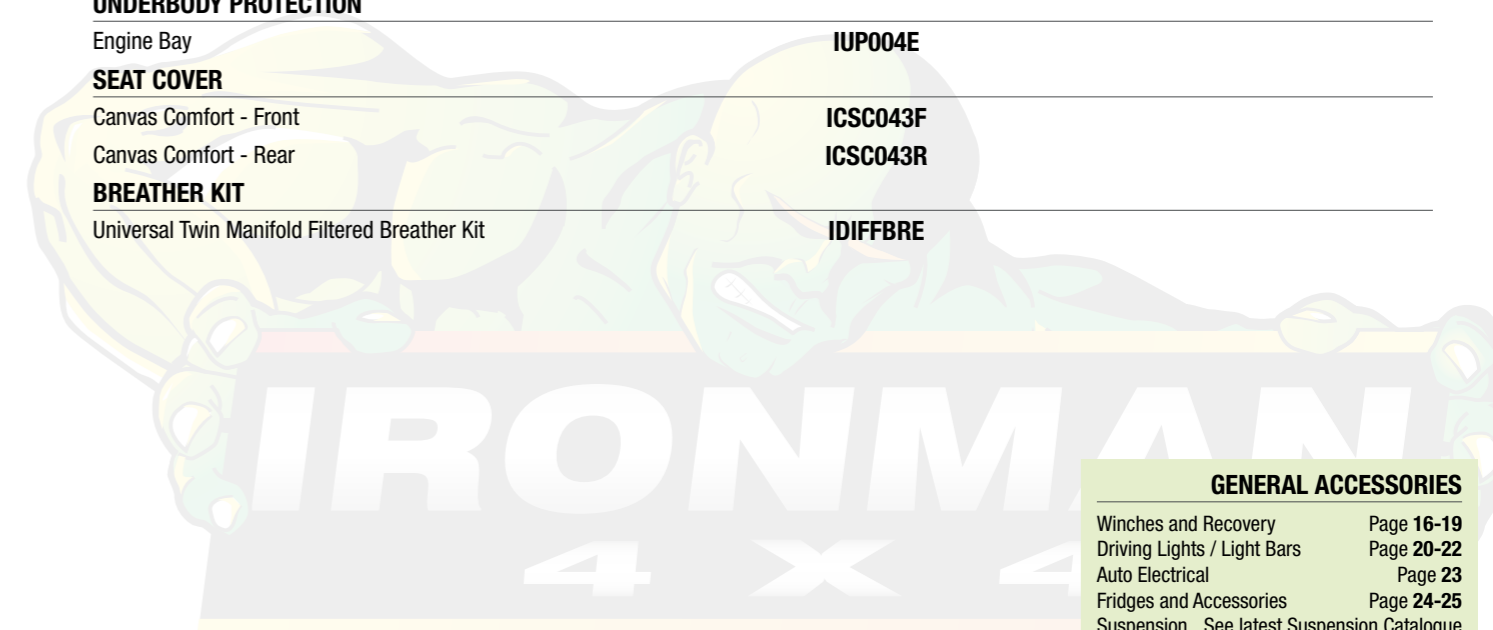

GENERAL ACCESSORIES

Winches and Recovery	Page 16-19
Driving Lights / Light Bars	Page 20-22
Auto Electrical	Page 23
Fridges and Accessories	Page 24-25
Suspension	See latest Suspension Catalogue

LANDCRUISER

200 Series 11/2007 to 1/2012
200 Series (Facelift) 2/2012 to 10/2015

LEXUS

LX 570



HZJ105, FZJ105 105 Series
3/1998 to 10/2007 Live Axle Front Susp.

LANDCRUISER

Accessory

Part No.

STEEL WINCH BULL BARS (AIR BAG COMPATIBLE) - 11/2007 to 2/2012

11/2007 TO 1/2012

Black Commercial	BBC025
Protector	BBT025
Premium Commercial Deluxe - 60.3mm Tube	BBP025

STEEL WINCH BULL BARS (AIR BAG COMPATIBLE) - 2/2012 to 2015

2/2012 TO 9/2015

Black Commercial	BBC043
Protector	BBT043
Premium Commercial Deluxe - 60.3mm Tube	BBP043

LOCKSAFE DRAWER SYSTEMS

Twin Drawers - 1000mm	ITD1000
Single Drawer - 1000mm	ISD1000
Wing Kit - 1000mm (May impede access to rear 240V outlet)	ITDW020

SNORKEL

Landcruiser 200 Series	ISNORKEL010
------------------------	-------------

BIGBORE EXHAUST SYSTEM

Landcruiser 200 Series 2000+, 4.5L Twin Turbo Diesel	IEXHAUST003
--	-------------

STEEL ROOF RACKS

Cage Style - 1.8m x 1.25m	IRRCAGE18
Cage Style - 2.2m x 1.25m	IRRCAGE22
Rooftop Tent Compatible - 1.8m x 1.25m	IRRTENT18
Rooftop Tent Compatible - 2.2m x 1.25m	IRRTENT22
Trade Style - 1.8m x 1.25m (Open end)	IRRTRADE18
Trade Style - 2.2m x 1.25m (Open end)	IRRTRADE22

ALLOY ROOF RACKS

Cage Style - 1.8m x 1.25m	IRRCAGE18-ALLOY
Cage Style - 2.2m x 1.25m	IRRCAGE22-ALLOY
Trade Style - 1.8m x 1.25m (Open end)	IRRTRADE18-ALLOY
Trade Style - 2.2m x 1.25m (Open end)	IRRTRADE22-ALLOY

ROOF RACK - MOUNTING KITS

Landcruiser 200 Mount Feet - 200mm (8 Feet)	IRRFEETLC200
---	--------------

UNDERBODY PROTECTION

Engine Bay and Transmission	IUP004K
Fuel Tank	IUP004F

• Fuel tank protection plates are not compatible with long range fuel tanks.

SEAT COVER

Canvas Comfort - Front	ICSC043F
Canvas Comfort - Rear	ICSC043R

BREATHER KIT

Universal Twin Manifold Filtered Breather Kit	IDIFFBRE
---	----------

Accessory

Part No.

STEEL WINCH BULL BARS (AIR BAG COMPATIBLE)

Black Commercial	BBC005
Deluxe Black Commercial	BBCD005
Protector	BBT005

STEEL SIDE STEPS, SIDE STEPS AND RAILS - Petrol Automatic model only

Side Steps	SS014
Side Steps and Rails	SSR014

LOCKSAFE DRAWER SYSTEMS

Twin Drawers - 1000mm	ITD1000
Single Drawer - 1000mm	ISD1000
Wing Kit - 1000mm (GXL 1998 to 2005)	ITDW018

SNORKEL

Landcruiser 105 Series	ISNORKEL003
------------------------	-------------

STEEL ROOF RACKS

Cage Style - 1.8m x 1.25m	IRRCAGE18
Rooftop Tent Compatible - 1.8m x 1.25m	IRRTENT18
Trade Style - 1.8m x 1.25m (Open end)	IRRTRADE18

ALLOY ROOF RACKS

Cage Style - 1.8m x 1.25m	IRRCAGE18-ALLOY
Trade Style - 1.8m x 1.25m (Open end)	IRRTRADE18-ALLOY

ROOF RACK - MOUNTING KITS

Landcruiser 100 Mount Feet - 100mm (8 Feet)	IRRFEETLC100
---	--------------

BREATHER KIT

Universal Twin Manifold Filtered Breather Kit	IDIFFBRE
---	----------

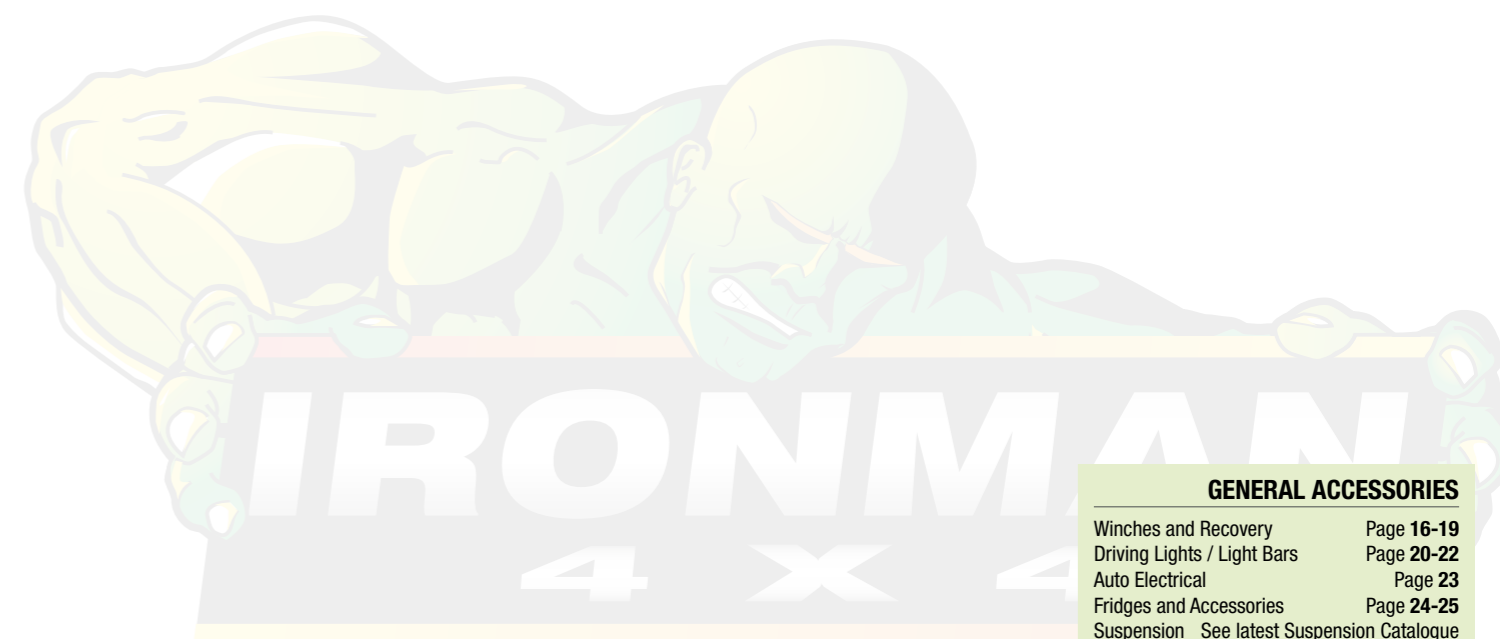

GENERAL ACCESSORIES

Winches and Recovery	Page 16-19
Driving Lights / Light Bars	Page 20-22
Auto Electrical	Page 23
Fridges and Accessories	Page 24-25
Suspension	See latest Suspension Catalogue

LANDCRUISER

HDJ100, UZJ100 100 Series
3/1998 to 10/2007 Ind. Front Susp.

LEXUS

LX 470



LEXUS

LX 450

LANDCRUISER

HZJ80, FZJ80 80 Series
1990 to 1998

Accessory

Part No.

STEEL WINCH BULL BARS (AIR BAG COMPATIBLE)

Black Commercial	BBC006
Deluxe Black Commercial	BBCD006
Protector	BBT006

LOCKSAFE DRAWER SYSTEMS

Twin Drawers - 1000mm	ITD1000
Single Drawer - 1000mm	ISD1000
Wing Kit - 1000mm (GXL 1998 to 2005)	ITDW018
Wing Kit - 1000mm (2005+)	ITDW019
Wing Kit - 1000mm (DX)	ITDW017

SNORKEL

Landcruiser 100 / Lexus LX 470	ISNORKEL003
--------------------------------	-------------

BIGBORE EXHAUST SYSTEM

Landcruiser 100 Series IFS 1998 to 2007, 4.2L Turbo Diesel	IEXHAUST010
--	-------------

STEEL ROOF RACKS

Cage Style - 1.8m x 1.25m	IRRCAGE18
Rooftop Tent Compatible - 1.8m x 1.25m	IRRTENT18
Trade Style - 1.8m x 1.25m (Open end)	IRRTRADE18

ALLOY ROOF RACKS

Cage Style - 1.8m x 1.25m	IRRCAGE18-ALLOY
Trade Style - 1.8m x 1.25m (Open end)	IRRTRADE18-ALLOY

ROOF RACK - MOUNTING KITS

Landcruiser 100 Mount Feet - 100mm (8 Feet)	IRRFEETLC100
---	--------------

BREATHER KIT

Universal Twin Manifold Filtered Breather Kit	IDIFFBRE
---	----------

Accessory

Part No.

STEEL WINCH BULL BARS (AIR BAG COMPATIBLE)

Black Commercial	BBC004
Deluxe Black Commercial	BBCD004
Protector	BBT004

STEEL SIDE STEPS, SIDE STEPS AND RAILS

Side Steps	SS013
Side Steps and Rails	SSR013

LOCKSAFE DRAWER SYSTEMS

Twin Drawers - 1000mm	ITD1000
Single Drawer - 1000mm	ISD1000
Wing Kit - 1000mm (GXL)	ITDW016
Wing Kit - 1000mm (DX)	ITDW015

SNORKEL

Landcruiser / Lexus LX 450	ISNORKEL004
----------------------------	-------------

STEEL ROOF RACKS

Cage Style - 1.4m x 1.25m	IRRCAGE14
Cage Style - 1.8m x 1.25m	IRRCAGE18
Cage Style - 2.2m x 1.25m	IRRCAGE22
Rooftop Tent Compatible - 1.8m x 1.25m	IRRTENT18
Rooftop Tent Compatible - 2.2m x 1.25m	IRRTENT22
Trade Style - 1.8m x 1.25m (Open end)	IRRTRADE18
Trade Style - 2.2m x 1.25m (Open end)	IRRTRADE22

ALLOY ROOF RACKS

Cage Style - 1.4m x 1.25m	IRRCAGE14-ALLOY
Cage Style - 1.8m x 1.25m	IRRCAGE18-ALLOY
Cage Style - 2.2m x 1.25m	IRRCAGE22-ALLOY
Trade Style - 1.8m x 1.25m (Open end)	IRRTRADE18-ALLOY
Trade Style - 2.2m x 1.25m (Open end)	IRRTRADE22-ALLOY

ROOF RACK - MOUNTING KITS

Gutter Mount Feet - 125mm (8 Feet)	IRRFEET125
------------------------------------	------------

BREATHER KIT

Universal Twin Manifold Filtered Breather Kit	IDIFFBRE
---	----------

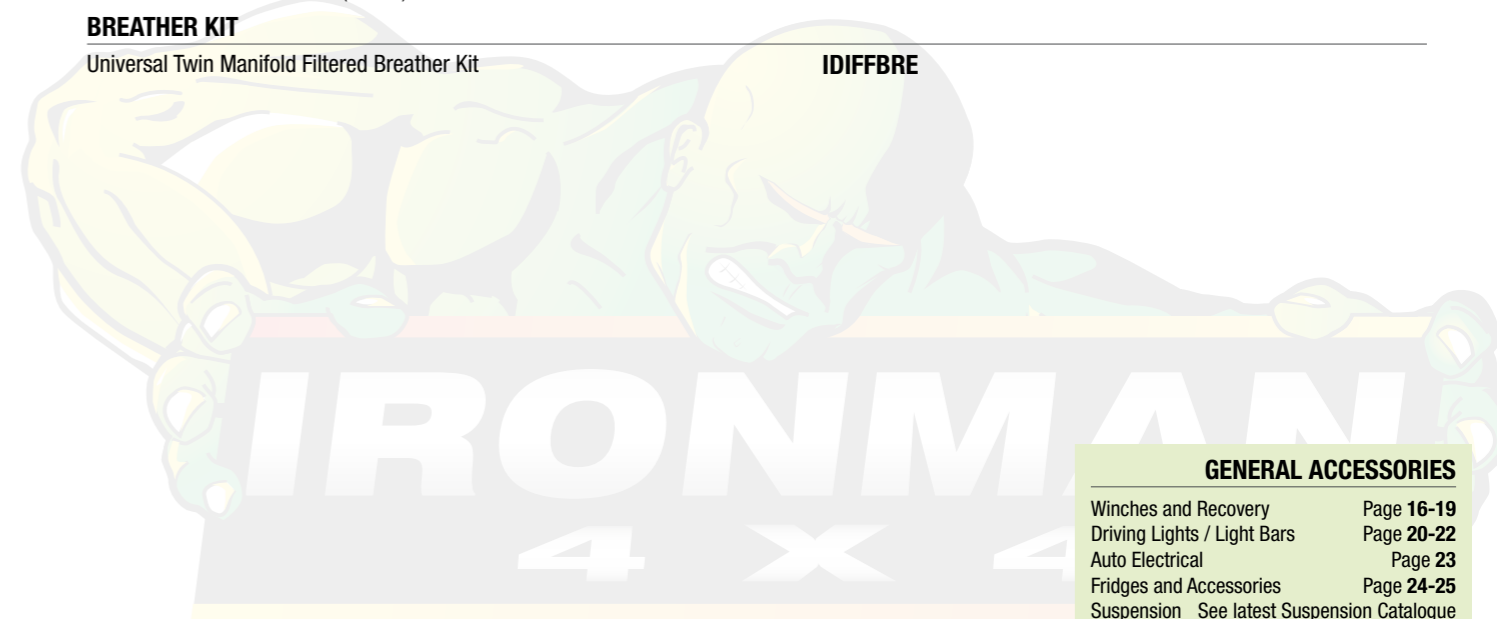

GENERAL ACCESSORIES

Winches and Recovery	Page 16-19
Driving Lights / Light Bars	Page 20-22
Auto Electrical	Page 23
Fridges and Accessories	Page 24-25
Suspension	See latest Suspension Catalogue

TOYOTA

TOYOTA



Accessory **Part No.** **Accessory** **Part No.**

STEEL WINCH BULL BARS (AIR BAG COMPATIBLE)

Black Commercial	BBC019E
Protector	BBT019E
Premium Commercial Deluxe - 60.3mm Tube	BBP019E

STEEL SIDE STEPS, SIDE STEPS AND RAILS

Side Steps	SS016
Side Steps and Rails	SSR016
Premium Side Steps and Rails - 60.3mm Tube	SSRP016

RECOVERY POINTS

Recovery Points Pair - 5000kg rating	IRP019
--------------------------------------	---------------

SNORKEL

Landcruiser 79 Series V8 2007+	ISNORKEL023
--------------------------------	--------------------

BIGBORE EXHAUST SYSTEM

Landcruiser 79 Series 4.5L V8 Turbo Diesel	IEXHAUST001
--	--------------------

SEAT COVER

Canvas Comfort - Front Bucket Pair	ICSC019F
Canvas Comfort - Front Bucket and 3/4 Bench	ICSC019F3/4

BREATHER KIT

Universal Twin Manifold Filtered Breather Kit	IDIFFBRE
---	-----------------

STEEL WINCH BULL BARS (AIR BAG COMPATIBLE)

Black Commercial	BBC019SC
Protector	BBT019SC
Premium Commercial Deluxe - 60.3mm Tube	BBP019SC

STEEL SIDE STEPS, SIDE STEPS AND RAILS

Side Steps	SS016SC
Side Steps and Rails	SSR016SC
Premium Side Steps and Rails - 60.3mm Tube	SSRP016SC

RECOVERY POINTS

Recovery Points Pair - 5000kg rating	IRP019
--------------------------------------	---------------

SNORKEL

Landcruiser 79 Series V8 9/2016+	ISNORKEL023
----------------------------------	--------------------

SEAT COVER

Canvas Comfort - Front	ICSC019SCF
------------------------	-------------------

BREATHER KIT

Universal Twin Manifold Filtered Breather Kit	IDIFFBRE
---	-----------------

2007 TO 8/2016

SINGLE CAB 9/2016+

Accessory

STEEL WINCH BULL BARS (AIR BAG COMPATIBLE)

Black Commercial	BBC019E
Protector	BBT019E
Premium Commercial Deluxe - 60.3mm Tube	BBP019E

STEEL SIDE STEPS, SIDE STEPS AND RAILS

Side Steps	SS019
Side Steps and Rails	SSR019
Premium Side Steps and Rails - 60.3mm Tube	SSRP019

RECOVERY POINTS

Recovery Points Pair - 5000kg rating	IRP019
--------------------------------------	---------------

SNORKEL

Landcruiser V8 2007+	ISNORKEL023
----------------------	--------------------

BIGBORE EXHAUST SYSTEM

Landcruiser 70 Series 11/2012 to 8/2016 4.5L V8 Turbo Diesel*	IEXHAUST013
---	--------------------

**Does not suit vehicle with DPF*

STEEL ROOF RACKS

Cage Style - 1.4m x 1.25m	IRRCAGE14
Cage Style - 1.8m x 1.25m	IRRCAGE18
Rooftop Tent Compatible - 1.8m x 1.25m	IRRTENT18
Trade Style - 1.8m x 1.25m (Open end)	IRRTRADE18

ALLOY ROOF RACKS

Cage Style - 1.4m x 1.25m	IRRCAGE14-ALLOY
Cage Style - 1.8m x 1.25m	IRRCAGE18-ALLOY
Trade Style - 1.4m x 1.25m (Open end)	IRROPEN14-ALLOY
Trade Style - 1.8m x 1.25m (Open end)	IRRTRADE18-ALLOY

ROOF RACK - MOUNTING KITS

Gutter Mount Feet - 125mm (8 Feet)	IRRFEE125
------------------------------------	------------------

SEAT COVER

Canvas Comfort - Front Bucket Pair	ICSC019F
Canvas Comfort - Front Bucket and 3/4 Bench	ICSC019F3/4
Canvas Comfort - Rear	ICSC019R

BREATHER KIT

Universal Twin Manifold Filtered Breather Kit	IDIFFBRE
---	-----------------

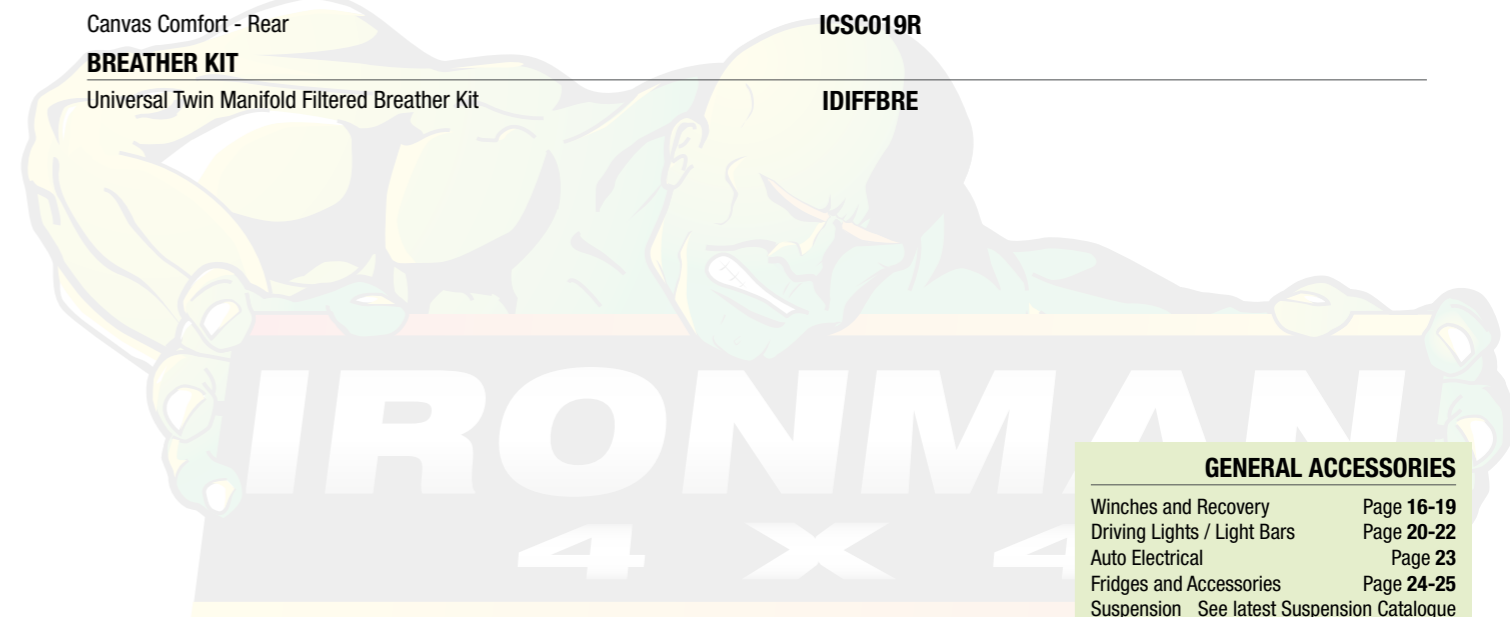

GENERAL ACCESSORIES

Winches and Recovery	Page 16-19
Driving Lights / Light Bars	Page 20-22
Auto Electrical	Page 23
Fridges and Accessories	Page 24-25
Suspension	See latest Suspension Catalogue



Accessory	Part No.
STEEL WINCH BULL BARS (AIR BAG COMPATIBLE)	
Black Commercial Protector	BBC019E
Premium Commercial Deluxe - 60.3mm Tube	BBP019E
LOCKSAFE DRAWER SYSTEMS	
Twin Drawers - 1300mm	ITD1300
Single Drawer - 1300mm	ISD1300
Wing Kit - 1300mm (GXC 2008+)	ITDW022
RECOVERY POINTS	
Recovery Points Pair - 5000kg rating	IRP019
SNORKEL	
Landcruiser 78 Series V8 2007+	ISNORKEL023
BIGBORE EXHAUST SYSTEM	
Landcruiser 78 Series 2007 to 8/2016 4.5L V8 Turbo Diesel*	IEXHAUST009
<i>*Does not suit vehicle with DPF</i>	
STEEL ROOF RACKS	
Cage Style - 1.4m x 1.25m	IRRCAGE14
Cage Style - 1.8m x 1.25m	IRRCAGE18
Cage Style - 2.2m x 1.25m	IRRCAGE22
Rooftop Tent Compatible - 1.8m x 1.25m	IRRTENT18
Rooftop Tent Compatible - 2.2m x 1.25m	IRRTENT22
Trade Style - 1.8m x 1.25m (Open end)	IRRTRADE18
Trade Style - 2.2m x 1.25m (Open end)	IRRTRADE22
ALLOY ROOF RACKS	
Cage Style - 1.4m x 1.25m	IRRCAGE14-ALLOY
Cage Style - 1.8m x 1.25m	IRRCAGE18-ALLOY
Cage Style - 2.2m x 1.25m	IRRCAGE22-ALLOY
Trade Style - 1.8m x 1.25m (Open end)	IRRTRADE18-ALLOY
Trade Style - 2.2m x 1.25m (Open end)	IRRTRADE22-ALLOY
ROOF RACK - MOUNTING KITS	
Gutter Mount Feet - 210mm (8 Feet)	IRRFEEET210
SEAT COVER	
Canvas Comfort - Front Bucket Pair	ICSC019F
Canvas Comfort - Front Bucket and 3/4 Bench	ICSC019F3/4
BREATHER KIT	
Universal Twin Manifold Filtered Breather Kit	IDIFFBRE

Accessory	Part No.
STEEL WINCH BULL BARS (AIR BAG COMPATIBLE)	
Black Commercial Protector	BBC019E
Premium Commercial Deluxe - 60.3mm Tube	BBP019E
STEEL SIDE STEPS, SIDE STEPS AND RAILS	
Side Steps	SS015
Side Steps and Rails	SSR015
Premium Side Steps and Rails - 60.3mm Tube	SSRP015
LOCKSAFE DRAWER SYSTEMS	
Twin Drawers - 900mm	ITD900
Single Drawer - 900mm	ISD900
Wing Kit - 900mm (76 Series GXL)	ITDW009
RECOVERY POINTS	
Recovery Points Pair - 5000kg rating	IRP019
SNORKEL	
Landcruiser V8 2007+	ISNORKEL023
BIGBORE EXHAUST SYSTEM	
Landcruiser 76 Series 2007 to 8/2016, 4.5L V8 Turbo Diesel*	IEXHAUST002
<i>*Does not suit vehicle with DPF</i>	
STEEL ROOF RACKS	
Cage Style - 1.4m x 1.25m	IRRCAGE14
Cage Style - 1.8m x 1.25m	IRRCAGE18
Cage Style - 2.2m x 1.25m	IRRCAGE22
Rooftop Tent Compatible - 1.8m x 1.25m	IRRTENT18
Rooftop Tent Compatible - 2.2m x 1.25m	IRRTENT22
Trade Style - 1.8m x 1.25m (Open end)	IRRTRADE18
Trade Style - 2.2m x 1.25m (Open end)	IRRTRADE22
ALLOY ROOF RACKS	
Cage Style - 1.4m x 1.25m	IRRCAGE14-ALLOY
Cage Style - 1.8m x 1.25m	IRRCAGE18-ALLOY
Cage Style - 2.2m x 1.25m	IRRCAGE22-ALLOY
Trade Style - 1.8m x 1.25m (Open end)	IRRTRADE18-ALLOY
Trade Style - 2.2m x 1.25m (Open end)	IRRTRADE22-ALLOY
ROOF RACK - MOUNTING KITS	
Gutter Mount Feet - 125mm (8 Feet)	IRRFEEET125
LONG RANGE FUEL TANK	
160L Diesel - 76 Series up to 11/2012	TANK001
SEAT COVER	
Canvas Comfort - Front Bucket Pair	ICSC019F
Canvas Comfort - Rear	ICSC019R
BREATHER KIT	
Universal Twin Manifold Filtered Breather Kit	IDIFFBRE

76 SERIES UP TO 11/2012

GENERAL ACCESSORIES

Winches and Recovery	Page 16-19
Driving Lights / Light Bars	Page 20-22
Auto Electrical	Page 23
Fridges and Accessories	Page 24-25
Suspension	See latest Suspension Catalogue



Accessory

Part No.

STEEL WINCH BULL BARS (AIR BAG COMPATIBLE)

Black Commercial	BBC018
Deluxe Black Commercial	BBCD018
Protector	BBT018

LOCKSAFE DRAWER SYSTEMS

Twin Drawers - 1300mm Troop Carrier LC78	ITD1300
Single Drawer - 1300mm	ISD1300

SNORKEL

Landcruiser 4.2L 1HZ Diesel	ISNORKEL009
-----------------------------	--------------------

STEEL ROOF RACKS

Cage Style - 1.4m x 1.25m	IRRCAGE14	78 SERIES ONLY
Cage Style - 1.8m x 1.25m	IRRCAGE18	
Cage Style - 2.2m x 1.25m	IRRCAGE22	
Rooftop Tent Compatible - 1.8m x 1.25m	IRRTENT18	
Rooftop Tent Compatible - 2.2m x 1.25m	IRRTENT22	
Trade Style - 1.8m x 1.25m (Open end)	IRRTRADE18	
Trade Style - 2.2m x 1.25m (Open end)	IRRTRADE22	

ALLOY ROOF RACKS

Cage Style - 1.4m x 1.25m	IRRCAGE14-ALLOY	78 SERIES ONLY
Cage Style - 1.8m x 1.25m	IRRCAGE18-ALLOY	
Cage Style - 2.2m x 1.25m	IRRCAGE22-ALLOY	
Trade Style - 1.4m x 1.25m (Open end)	IRROPEN14-ALLOY	
Trade Style - 1.8m x 1.25m (Open end)	IRRTRADE18-ALLOY	
Trade Style - 2.2m x 1.25m (Open end)	IRRTRADE22-ALLOY	

ROOF RACK - MOUNTING KITS

Gutter Mount Feet - 210mm (8 Feet)	IRRFEET210
------------------------------------	-------------------

BREATHER KIT

Universal Twin Manifold Filtered Breather Kit	IDIFFBRE
---	-----------------

Accessory

Part No.

LOCKSAFE DRAWER SYSTEMS

Twin Drawers - 1000mm	ITD1000
Single Drawer - 1000mm	ISD1000
Wing Kit - 1000mm	ITDW013

STEEL ROOF RACKS

Cage Style - 1.4m x 1.25m	IRRCAGE14
Cage Style - 1.8m x 1.25m	IRRCAGE18
Cage Style - 2.2m x 1.25m	IRRCAGE22
Rooftop Tent Compatible - 1.8m x 1.25m	IRRTENT18
Rooftop Tent Compatible - 2.2m x 1.25m	IRRTENT22
Trade Style - 1.8m x 1.25m (Open end)	IRRTRADE18
Trade Style - 2.2m x 1.25m (Open end)	IRRTRADE22

ALLOY ROOF RACKS

Cage Style - 1.4m x 1.25m	IRRCAGE14-ALLOY
Cage Style - 1.8m x 1.25m	IRRCAGE18-ALLOY
Cage Style - 2.2m x 1.25m	IRRCAGE22-ALLOY
Trade Style - 1.4m x 1.25m (Open end)	IRROPEN14-ALLOY
Trade Style - 1.8m x 1.25m (Open end)	IRRTRADE18-ALLOY
Trade Style - 2.2m x 1.25m (Open end)	IRRTRADE22-ALLOY

ROOF RACK - MOUNTING KITS

Gutter Mount Feet - 125mm (8 Feet)	IRRFEET125
------------------------------------	-------------------

BREATHER KIT

Universal Twin Manifold Filtered Breather Kit	IDIFFBRE
---	-----------------

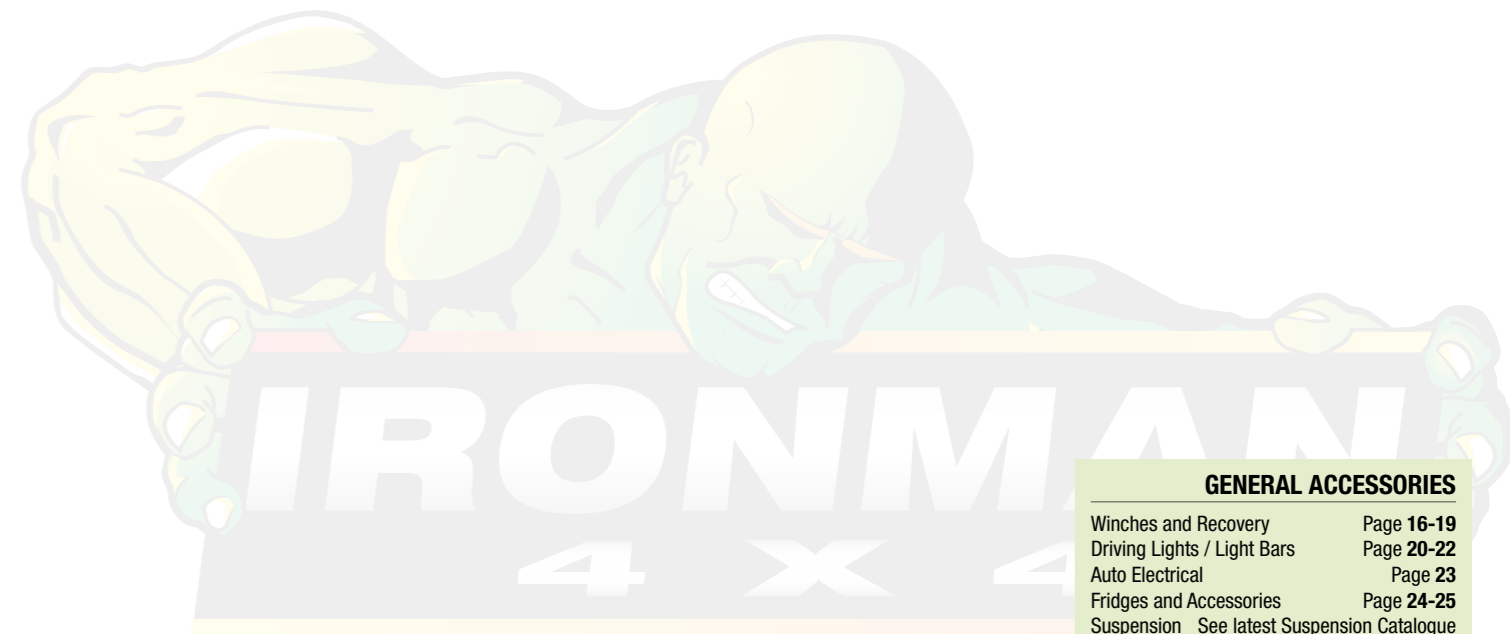

GENERAL ACCESSORIES

Winches and Recovery	Page 16-19
Driving Lights / Light Bars	Page 20-22
Auto Electrical	Page 23
Fridges and Accessories	Page 24-25
Suspension	See latest Suspension Catalogue



Accessory	Part No.	
STEEL WINCH BULL BARS (AIR BAG COMPATIBLE)		11/2009 TO 10/2013
Black Commercial	BBC029	
Deluxe Black Commercial	BBCD029	
Protector	BBT029	
STEEL WINCH BULL BARS (AIR BAG COMPATIBLE)		FACELIFT MODEL 10/2013+
Black Commercial	BBC047	
Deluxe Black Commercial	BBCD047	
Protector	BBT047	
Polished Alloy	BBA047	
STEEL SIDE STEPS, SIDE STEPS AND RAILS		
Side Steps	SS047	
Side Steps and Rails	SSR047	
SNORKEL		
3L D4D TDi / 4L Petrol V6	ISNORKEL035	
2.8L D4D TDi / 4L Petrol V6	ISNORKEL035	
BIGBORE EXHAUST SYSTEM		
3L D4D LWB*	IEXHAUST004	
<i>*To 9/2017</i>		
STEEL ROOF RACKS		
Cage Style - 1.8m x 1.25m	IRRCAGE18	
Rooftop Tent Compatible - 1.8m x 1.25m	IRRTENT18	
Trade Style - 1.8m x 1.25m (Open end)	IRRTRADE18	
ALLOY ROOF RACKS		
Cage Style - 1.8m x 1.25m	IRRCAGE18-ALLOY	
Trade Style - 1.8m x 1.25m (Open end)	IRRTRADE18-ALLOY	
ROOF RACK - MOUNTING KITS		
Toyota Prado 150 Mount Feet (2 Feet)	IRRFEEPRADO150	
UNDERBODY PROTECTION		
Engine Bay and Transmission	IUP003K	
Fuel Tank	IUP003F	
• Fuel tank protection plates are not compatible with long range fuel tanks.		
SEAT COVER		
Canvas Comfort - Front	ICSC047F	
Canvas Comfort - Rear	ICSC047R	
BREATHER KIT		
Universal Twin Manifold Filtered Breather Kit	IDIFFBRE	

Accessory	Part No.
STEEL WINCH BULL BARS (AIR BAG COMPATIBLE)	
Black Commercial	BBC008
Deluxe Black Commercial	BBCD008
Protector	BBT008
STEEL SIDE STEPS, SIDE STEPS AND RAILS	
Side Steps	SS017
Side Steps and Rails	SSR004
LOCKSAFE DRAWER SYSTEMS	
Twin Drawers - 900mm	ITD900
Single Drawer - 900mm	ISD900
SNORKEL	
3L D4D TDi / 4L Petrol V6	ISNORKEL006
BIGBORE EXHAUST SYSTEM - Does not suit 1KZ-TE Engine	
Prado LWB 120 Series, 3L D4D 1KD-FTV Engine ONLY	IEXHAUST004
STEEL ROOF RACKS	
Cage Style - 1.8m x 1.25m	IRRCAGE18
Rooftop Tent Compatible - 1.8m x 1.25m	IRRTENT18
Trade Style - 1.8m x 1.25m (Open end)	IRRTRADE18
ALLOY ROOF RACKS	
Cage Style - 1.8m x 1.25m	IRRCAGE18-ALLOY
Trade Style - 1.8m x 1.25m (Open end)	IRRTRADE18-ALLOY
ROOF RACK - MOUNTING KITS	
Gutter Mount Feet - 200mm (8 Feet)	IRRFEEELC200
UNDERBODY PROTECTION	
Engine Bay and Transmission	IUP002K
BREATHER KIT	
Universal Twin Manifold Filtered Breather Kit	IDIFFBRE

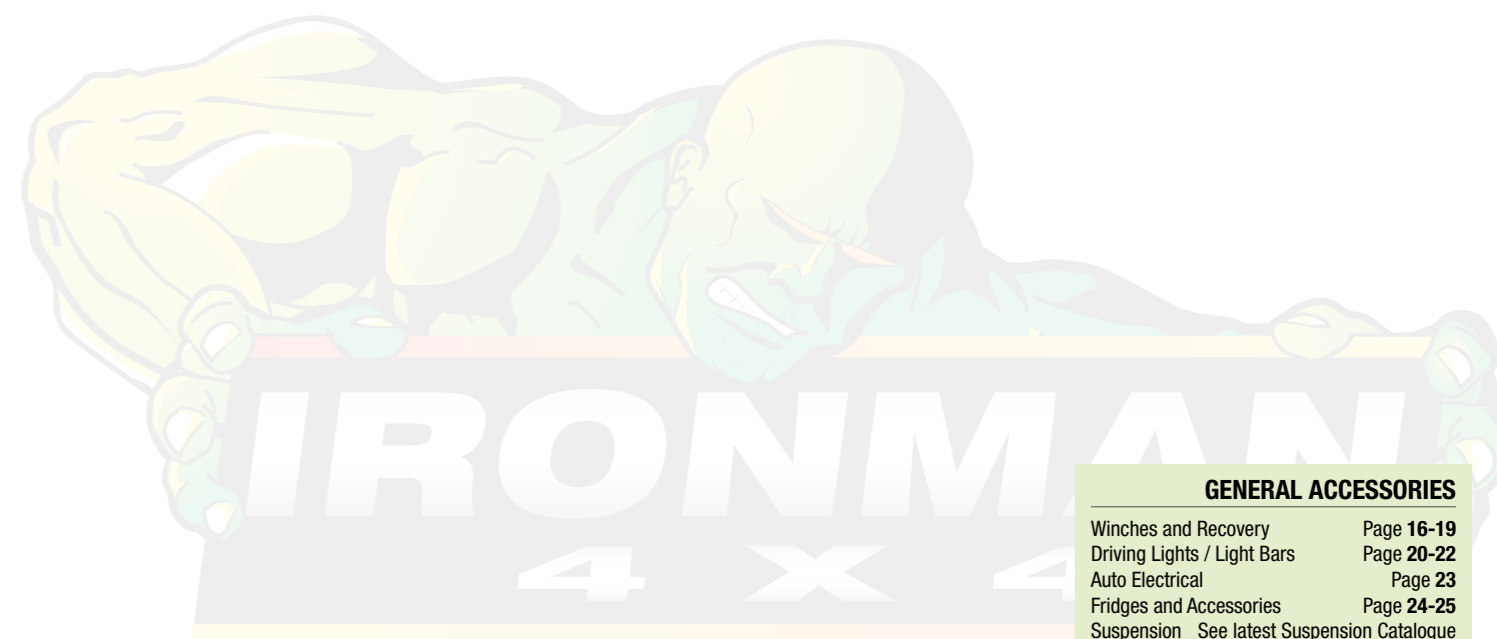

GENERAL ACCESSORIES

Winches and Recovery	Page 16-19
Driving Lights / Light Bars	Page 20-22
Auto Electrical	Page 23
Fridges and Accessories	Page 24-25
Suspension	See latest Suspension Catalogue



Accessory	Part No.
STEEL WINCH BULL BARS (AIR BAG COMPATIBLE)	
Black Commercial	BBC007
Deluxe Black Commercial	BBCD007
Protector	BBT007
SNORKEL	
3.4L Petrol V6	ISNORKEL005
LOCKSAFE DRAWER SYSTEMS	
Twin Drawers - 900mm	ITD900
Single Drawer - 900mm	ISD900
Wing Kit - 900mm (GXL)	ITDW004
STEEL ROOF RACKS	
Cage Style - 1.8m x 1.25m	IRRCAGE18
Rooftop Tent Compatible - 1.8m x 1.25m	IRRTENT18
Trade Style - 1.8m x 1.25m (Open end)	IRRTRADE18
ALLOY ROOF RACKS	
Cage Style - 1.8m x 1.25m	IRRCAGE18-ALLOY
Trade Style - 1.8m x 1.25m (Open end)	IRRTRADE18-ALLOY
ROOF RACK - MOUNTING KITS	
Gutter Mount Feet - 125mm (8 Feet)	IRRFEET125
BREATHER KIT	
Universal Twin Manifold Filtered Breather Kit	IDIFFBRE

Accessory	Part No.
STEEL WINCH BULL BARS (AIR BAG COMPATIBLE)	
Deluxe Black Commercial	BBCD060
• Can also be fitted to both 2WD and 4WD models.	
STEEL SIDE STEPS, SIDE STEPS AND RAILS	
Side Steps	SS034
Side Rails	SS034 RAIL
Side Steps and Rails	SSR034
LOCKSAFE DRAWER SYSTEMS	
Twin Drawers - 1300mm	ITD1300
Single Drawer - 1300mm	ISD1300
SNORKEL	
Amarok	ISNORKEL037
UNDERBODY PROTECTION	
Engine Bay and Transmission	IUP012K
CANOPY ABS PLASTIC (SIDE LIFT UP WINDOWS) - Fits 4x4 and 4x2 Dual Cab models	
Pre-Primed	CANOPY009-P
Candy White (B4B4)	CANOPY009-W
SEAT COVER	
Canvas Comfort - Front	ICSC060F
Canvas Comfort - Rear	ICSC060R
BREATHER KIT	
Universal Twin Manifold Filtered Breather Kit	IDIFFBRE

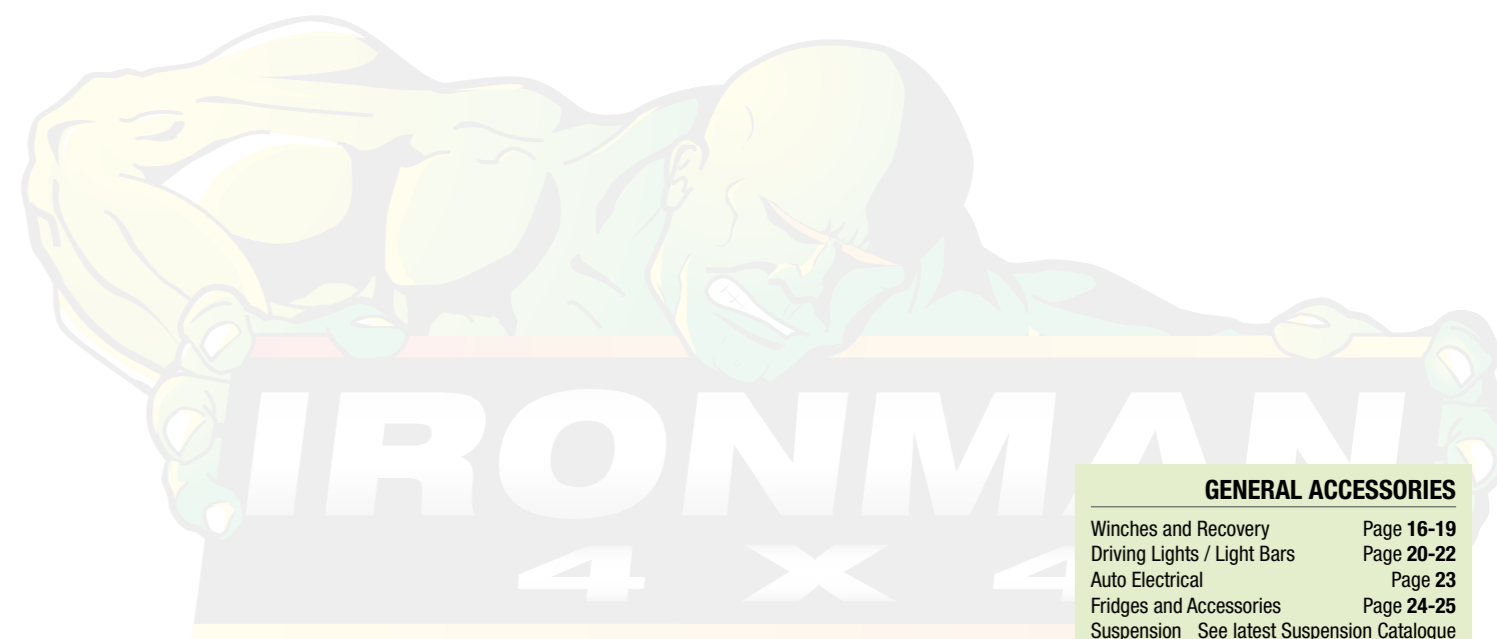

GENERAL ACCESSORIES

Winches and Recovery	Page 16-19
Driving Lights / Light Bars	Page 20-22
Auto Electrical	Page 23
Fridges and Accessories	Page 24-25
Suspension	See latest Suspension Catalogue



Accessory	Part No.
STEEL WINCH BULL BARS (AIR BAG COMPATIBLE)	
Black Commercial	BBC034
Deluxe Black Commercial	BBCD034
Protector	BBT034
• Can also be fitted to both 2WD and 4WD models.	
STEEL SIDE STEPS, SIDE STEPS AND RAILS	
Side Steps	SS034
Side Rails	SS034 RAIL
Side Steps and Rails	SSR034
LOCKSAFE DRAWER SYSTEMS	
Twin Drawers - 1300mm	ITD1300
Single Drawer - 1300mm	ISD1300
Wing Kit - 1300mm*	ITDW040
*Designed to suit factory tubs, will not suit ute liner without modification	
SNORKEL	
Amarok	ISNORKEL037
UNDERBODY PROTECTION	
Engine Bay and Transmission	IUP012K
CANOPY ABS PLASTIC (SIDE LIFT UP WINDOWS) - Fits 4x4 and 4x2 Dual Cab models	
Pre-Primed	CANOPY009-P
Candy White (B4B4)	CANOPY009-W
DUAL CAB UTE LINER (COMPATIBLE WITH ABS CANOPY) - Fits 4x4 and 4x2 Dual Cab models	
<i>Superlock kit must be used if fitting Ironman 4x4 Canopy to Ute Liner</i>	
Amarok 2011+	LINER010
Superlock Kit	SUPERLOCK
• Not compatible with hardtop lids and factory sports bars.	
BREATHER KIT	
Universal Twin Manifold Filtered Breather Kit	IDIFFBRE

Spare Part Description	Part No.
BULL BARS	
Pinch Weld for Bumper Cut - 1m	BBPART006
Bull Bar Indicators - New Style (Pair)	BBPART007
Bull Bar Fog Light Part - New Style (Pair)	BBPART008
Plastic Light Pod and Bracket - New Style (Each)	BBPART009
Bumper Override BBT - New Style (Pair)	BBPART010
Bumper Override BBC-D - New Style (Pair)	BBPART011
New Style Wiring Loom	BBPART012
BB002 Hilux Vigo Plastic Inserts (Pair)	BBPART013
Ironman 4X4 Bull Bar Badge (Each)	BBPART014
Bumper Override Suits BBC-D 033 and N/Loop Bars	BBPART015
Aerial Tab	BBPART016
Indicator Light Brackets	BBPART017
Ironman 4x4 Logo for Roof Cages	BBPART018
Ironman 4x4 Logo for Resin Style SS/SSR Rails	BBPART019
Bumper Override Suits BBCD035	BBPART020
Washer Bottle Suits 050	BBPART021
Single Light Pod and Bracket	BBPART022
Bull Bar Loop 'O' Ring	BBPART023
Bumper Overrides BBD/BBCD 050 On	BBPART024
Bumper Overrides T 050 On	BBPART025

Spare Part Description	Part No.
BULL BAR LOOPS	
Triple Loop to suit Protector Bull Bar	BBPARTLOOP001
Triple Loop to suit Protector Bull Bar	BBPARTLOOP002
Triple Loop to suit Protector Bull Bar	BBPARTLOOP003
Triple Loop to suit Protector Bull Bar	BBPARTLOOP004
Triple Loop to suit Protector Bull Bar	BBPARTLOOP005
Triple Loop to suit Protector Bull Bar	BBPARTLOOP006
Triple Loop to suit Protector Bull Bar	BBPARTLOOP007
Triple Loop to suit Protector Bull Bar	BBPARTLOOP008
Triple Loop to suit Protector Bull Bar	BBPARTLOOP009
Triple Loop to suit Protector Bull Bar	BBPARTLOOP010
Triple Loop to suit Protector Bull Bar	BBPARTLOOP011
Triple Loop to suit Protector Bull Bar	BBPARTLOOP012
Triple Loop to suit Protector Bull Bar	BBPARTLOOP013
Triple Loop to suit Protector Bull Bar	BBPARTLOOP014
Triple Loop to suit Protector Bull Bar	BBPARTLOOP015
Triple Loop to suit Protector Bull Bar	BBPARTLOOP016
Triple Loop to suit Protector Bull Bar	BBPARTLOOP019
Triple Loop to suit Protector Bull Bar	BBPARTLOOP020
Triple Loop to suit Protector Bull Bar	BBPARTLOOP024
Triple Loop to suit Protector Bull Bar	BBPARTLOOP025
Triple Loop to suit Protector Bull Bar	BBPARTLOOP027
Triple Loop to suit Protector Bull Bar	BBPARTLOOP029
Triple Loop to suit Protector Bull Bar	BBPARTLOOP031
Triple Loop to suit Protector Bull Bar	BBPARTLOOP033

Spare Part Description

Part No.

BULL BAR LOOPS CONTINUED	
Triple Loop to suit Protector Bull Bar	BBPARTLOOP034
Triple Loop to suit Protector Bull Bar	BBPARTLOOP037
Triple Loop to suit Protector Bull Bar	BBPARTLOOP038
Triple Loop to suit Protector Bull Bar	BBPARTLOOP039
Triple Loop to suit Protector Bull Bar	BBPARTLOOP040
Triple Loop to suit Protector Bull Bar	BBPARTLOOP041
Triple Loop to suit Protector Bull Bar	BBPARTLOOP042
Triple Loop to suit Protector Bull Bar	BBPARTLOOP043
Triple Loop to suit Protector Bull Bar	BBPARTLOOP044
Triple Loop to suit Protector Bull Bar	BBPARTLOOP045
Triple Loop to suit Protector Bull Bar	BBPARTLOOP047
Triple Loop to suit Protector Bull Bar	BBPARTLOOP048
Triple Loop to suit Protector Bull Bar	BBPARTLOOP049
Triple Loop to suit Protector Bull Bar	BBPARTLOOP050

DRIVING LIGHTS	
IHID LENS	
IHID LENS COVER	
IHIDBALLAST	
IHIDBULB	

INSTANT AWNINGS	
'L' Mounting Brackets	IAWNINGSPPARE001
Hinge Joint for Poles	IAWNINGSPPARE002
Strap and Buckle	IAWNINGSPPARE003
Foot Piece with Rope	IAWNINGSPPARE004
End Pin	IAWNINGSPPARE005
Swivel Spacer	IAWNINGSPPARE006
Twist Lock	IAWNINGSPPARE007
Outer Pole 25mm - Tube Only	IAWNINGSPPARE008
Inner Pole 22mm - Tube Only	IAWNINGSPPARE009
Awning Cover	IAWNINGSPPARE010
Square Rubber Catch	IAWNINGSPPARE011
2.0 Horizontal External Pole	IAWNINGSPPARE012
2.5 Horizontal External Pole	IAWNINGSPPARE013
Plastic Clip Suits IAWNING Room / Net	IAWNINGSPPARE014
'L' Shaped Bracket for Awning	IAWNINGBRACKET

WINCHES	
Remote with Wireless Receiver Unit	WWB001
Solenoid	WWB002
9500lb Motor	WWB003
12000lb Motor	WWB004
Breather Kit for Motor	WWB005
Tie Bars - New Shape (x2)	WWB006
Cutch Handle	WWB007
9500lb Gearbox Complete	WWB008

Spare Part Description

Part No.

WINCHES CONTINUED	
12000lb Gearbox Complete	WWB009
Brush Kit for Motor	WWB010
Replacement Hook	WWB011
Mounting Plate Motor End	WWB012
Mounting Plate Gearbox End	WWB013
Complete Control Box with Remote	WWB014
Wireless Plug	WWB015
Winch Cam Lock Brake System	WWB016
Drum for Winches	WWB017
Gasket - Electric Motor 9500lb/12000lb	WWB018
Box for WWB9500	WWB019
Box for WWB9500SR	WWB020
Box for WWB12000	WWB021
Box for WWB12000SR	WWB022
Control Box Lead Socket	WWB023
Plug In Lead	WWB024
Internal Brake Replacement	WWB025

CANOPY	
Rear Door Handle and Key Set all Models	CANOPYSPARE001
Canopy Rear Strut 001A/002A/005A/006A/007A	CANOPYSPARE002
Canopy Rear Strut 003A/004A	CANOPYSPARE003
Plate Side Lock Set all Models to 008A	CANOPYSPARE004
Canopy Internal Light Suits all Models	CANOPYSPARE005
Rubber Seal Kit Suits all Models to 007A	CANOPYSPARE006
Rubber Seal Kit Suits 008A to 011A	CANOPYSPARE007
Bolt Set Rear Window Suits 003A/004A	CANOPYSPARE008
Edge Seal for 006A	CANOPYSPARE009
Edge Seal for 005A	CANOPYSPARE010
Edge Seal for 003A/004A/007A	CANOPYSPARE011
Edge Seal for 001A/002A	CANOPYSPARE012
Replacement LED Brakelight Suits all Models	CANOPYSPARE013
Sliding Window L/H Suits 001/2/5/6/7/009A	CANOPYSPARE014
Sliding Window L/H Suits 003A/004A	CANOPYSPARE015
Sliding Window R/H Suits 001/2/5/6/7/009A	CANOPYSPARE016
Sliding Window R/H Suits 003A/004A	CANOPYSPARE017
Rear Glass Rod Set 001A to 007A also 009A	CANOPYSPARE018
Plate Side Lock Set Suits 010A	CANOPYSPARE019
Plate Suits Lock Set Suits 009A and 011A	CANOPYSPARE020
R/H Sliding Window Suits 008A/010/011/012A	CANOPYSPARE021
L/H Sliding Window Suits 008A/010/011/012A	CANOPYSPARE022
Rear Strut Suits 011A	CANOPYSPARE023
Bolt Set Rear Window 001A/2/5/6/007A	CANOPYSPARE024
Rear Window Hinge Suits 001A/2/5/6/7/009A	CANOPYSPARE026
Rear Window Hinge Suits 008A	CANOPYSPARE027
Rear Window Hinge Suits 010A	CANOPYSPARE028
Rear Window Hinge Suits 011A	CANOPYSPARE029

SPARE PARTS

SPARE PARTS

Spare Part Description

Part No.

CANOPIES CONTINUED	
Use CANOPYSPARE017	CANOPYSPARE030
Bolt Set Rear Window Suits 010A	CANOPYSPARE031
Front Sliding Window Series 3	CANOPYSPARE032
Rear Window Strut 010A	CANOPYSPARE033
Rear Window Srut 008A	CANOPYSPARE034
Rotary Lock Set Suits 010A to 012A	CANOPYSPARE035
Mounting Kit Suits 001A	CANOPYSPARE036
Mounting Kit Suits 002A	CANOPYSPARE037
Mounting Kit Suits 003A	CANOPYSPARE038
Mounting Kit Suits 004A	CANOPYSPARE039
Mounting Kit Suits 005A	CANOPYSPARE040
Mounting Kit Suits 006A	CANOPYSPARE041
Mounting Kit Suits 007A	CANOPYSPARE042
Mounting Kit Suits 008A	CANOPYSPARE043
Mounting Kit Suits 009A	CANOPYSPARE044
Mounting Kit Suits 010A	CANOPYSPARE045
Mounting Kit Suits 011A	CANOPYSPARE046
Mounting Kit Suits 012A	CANOPYSPARE047
Lift Up Window L/H Suits 001A/2/5/6/7/009A	CANOPYSPARE048
Lift Up Window R/H Suits 001A/2/5/6/7/009A	CANOPYSPARE049
Lift Up Window L/H Suits 003A/004A	CANOPYSPARE050
Lift Up Window R/H Suits 003A/004A	CANOPYSPARE051
Lift Up Window L/H Suits 008A/010/011A	CANOPYSPARE052
Lift Up Window R/H Suits 008A/010/011A	CANOPYSPARE053
Rubber Window Seal Kit 001A/2/3/004A	CANOPYSPARE054
Rubber Window Seal Kit 008A	CANOPYSPARE055
Rubber Window Seal Kit 010A	CANOPYSPARE056
Rubber Window Seal Kit 011A	CANOPYSPARE057
Bolt Set Rear Window Lower Series 1	CANOPYSPARE058
Bolt Set Rear Window Suits 010A	CANOPYSPARE059
Ironman 4x4 Resin Logo Small	CANOPYSPARE060
Handle Set 4 Lift Up Window Series ½	CANOPYSPARE061
Handle Set 4 Lift Up Window Series 3	CANOPYSPARE062
Rear Window Strut Suits 009A	CANOPYSPARE063
Front Sliding Window 011A/012A	CANOPYSPARE064
Handle Set 2 R/H Lift Up Window Series 3	CANOPYSPARE065
L/H Lift Up Window Suits CANOPY014	CANOPYSPARE068
R/H Lift Up Window Suits CANOPY014	CANOPYSPARE069
Rear Window Suits CANOPY001	CANOPY001-WINDOW
Rear Window Suits CANOPY002	CANOPY002-WINDOW
Rear Window Suits CANOPY003	CANOPY003-WINDOW
Rear Window Suits CANOPY004	CANOPY004-WINDOW
Rear Window Suits CANOPY005	CANOPY005-WINDOW
Rear Window Suits CANOPY006	CANOPY006-WINDOW
Rear Window Suits CANOPY007	CANOPY007-WINDOW
Rear Window Suits CANOPY008	CANOPY008-WINDOW
	CANOPY009-WINDOW

Spare Part Description

Part No.

CANOPIES CONTINUED	
	CANOPY010-WINDOW
	CANOPY012-WINDOW
	CANOPY010-CL WINDOW
	CANOPY014-CL WINDOW
	CANOPY019-CL WINDOW
	CANOPY020-CL WINDOW
	CANFIBRESPARE002
	CANFIBRESPARE006
	CANFIBRESPARE007
	CANFIBRESPARE008
	CANFIBRESPARE009
	CANFIBRESPARE010
	CANFIBRESPARE011
	CANFIBRESPARE012
	CANFIBRESPARE013
	CANFIBRESPARE014
	CANFIBRESPARE015
	CANFIBRESPARE016
	CANFIBRESPARE017
	CANFIBRESPARE018

CANOPY / ROOF RACKS	
Cross Bar	IRRCROSSBAR001

ROOFTOP TENTS	
Travel Cover for A214:B235	IROOFTENTSPARE001
Mattress Cover	IROOFTENTSPARE002
Mounting Extrusions x 2	IROOFTENTSPARE003
Mounting Sliding Plate and Bolt	IROOFTENTSPARE004
Mounting Clamp	IROOFTENTSPARE005
Ladder Bracket x 2	IROOFTENTSPARE006
Bungee Cords x 4	IROOFTENTSPARE007
Window Rods x 6	IROOFTENTSPARE008
Tent Hinges - Internal	IROOFTENTSPARE009
Straps for Tent Cover x 2	IROOFTENTSPARE010
Front Ext Bow	IROOFTENTSPARE011
Base Extrusion 1295mm	IROOFTENTSPARE012
Base Extrusion 1130mm	IROOFTENTSPARE013
Base Mid Extrusion Tongue/Groove	IROOFTENTSPARE014
Tent Base Corner Piece	IROOFTENTSPARE015
Main Ladder	IROOFTENTSPARE016
Tent Fly Sheet	IROOFTENTSPARE017
Zip On Base for Cover	IROOFTENTSPARE018
Mattress	IROOFTENTSPARE019
Roof Top Tent Bow	IROOFTENTSPARE020

Spare Part Description	Part No.
------------------------	----------

FRIDGES	
Lid Suits 30, 40 and 50L	IFRIDGESPART001
12V Lead for Fridge	IFRIDGESPART002
240V Lead for Fridge	IFRIDGESPART003
European Power Lead for Fridges	IFRIDGESPART004
30L Internal Basket	IFRIDGESPART005
40L Internal Basket	IFRIDGESPART006
50L Internal Basket	IFRIDGESPART007
Fridge Internal LED Light Suits all Fridges	IFRIDGESPART008
Digital Control Panel (30, 40, 50L)	IFRIDGESPART009
Fridge Control Pcb (30, 40, 50L)	IFRIDGESPART010
Fridge Compressor Control Suits all Fridges	IFRIDGESPART011
Fridge Battery Protection (30, 40, 50L)	IFRIDGESPART012
Fridge DC Fan (30, 40, 50L)	IFRIDGESPART013
Digital Control Panel 65L Dual Control	IFRIDGESPART014
Fridge Digital Control Panel 74L Single	IFRIDGESPART015
Fridge Spare DC Fan (65/74L)	IFRIDGESPART016
Spare Hinge Suits 65/74L	IFRIDGESPART017
American Lead for Fridge	IFRIDGESPART018
65L Internal Small Basket	IFRIDGESPART019
65L Internal Large Basket	IFRIDGESPART020
74L Internal Small Basket	IFRIDGESPART021
74L Internal Large Basket	IFRIDGESPART022
	IFRIDGESPART023
	IFRIDGESPART024

SNORKELS	
Snorkel Mesh Inset Suits 3" and 3.5" Hat	ISNORKELSPARE001
Overflow Bottle Suits ISNORKEL020	ISNORKELSPARE002
	ISNORKEL 3" HAT
	ISNORKEL 3.5" HAT
	ISNORKEL 4" HAT

SWAGS	
	ISWAGPART001
	ISWAGPART002
	ISWAGSPARE001
	ISWAGSPARE002

Part Number	Page	Part Number	Page	Part Number	Page	Part Number	Page
ATLAS001	42	BBCD024	68	BBT043	94	CANOPY010-M	45, 47, 67
BBA038	46	BBCD027	54	BBT044	53	CANOPY010-MG	45, 47, 67
BBA047	104	BBCD029	104	BBT045	70	CANOPY010-MG	45, 47, 67
BBA048	75	BBCD031	73	BBT046	85	CANOPY010-P	45, 47, 67
BBA050	72	BBCD033	89	BBT047	104	CANOPY010-S	45, 47, 67
BBA051	88	BBCD034	108	BBT048	75	CANOPY010-SB	45, 47, 67
BBA052	62	BBCD035	63	BBT050	72	CANOPY010-TR	45, 47, 67
BBA054	44	BBCD037	87	BBT051	88	CANOPY010-WB	45, 47, 67
BBA056	44, 49, 93	BBCD038	46	BBT053	92	CANOPY011-P	58
BBA056-VX	93	BBCD039	66	BBT054	44, 49	CANOPY011-SW	58
BBC001	91	BBCD040	52	BBT056	93	CANOPY012-B	52
BBC002	90	BBCD041	58	BBT056-VX	93	CANOPY012-BS	52
BBC004	97	BBCD042	76, 79	BBT057	50, 51	CANOPY012-P	52
BBC005	95	BBCD044	53	BBT058	57	CANOPY012-S	52
BBC006	96	BBCD045	70	BBT059	69	CANOPY012-SW	52
BBC007	106	BBCD046	85	CAN001	42	CANOPY013-BS	75
BBC008	105	BBCD047	104	CANFIBRE001	89, 90	CANOPY013-CB	75
BBC010	43	BBCD048	75	CANFIBRE048-BS	75	CANOPY013-HG	75
BBC012	84, 76	BBCD049	61	CANFIBRE048-CB	75	CANOPY013-PW	75
BBC013	79, 79	BBCD050	72	CANFIBRE048-HG	75	CANOPY013-SG	75
BBC014	48	BBCD051	88	CANFIBRE048-PW	75	CANOPY013-WP	75
BBC016	74	BBCD052	62	CANFIBRE048-SG	75	CANOPY014-BM	72
BBC018	102	BBCD053	92	CANFIBRE048-WP	75	CANOPY014-EG	72
BBC019E	98-101	BBCD054	44, 49	CANFIBRE050-BM	72	CANOPY014-IB	72
BBC019SC	98	BBCD055	44, 49	CANFIBRE050-EG	72	CANOPY014-P	72
BBC020	55, 59	BBCD057	50, 51	CANFIBRE050-IB	72	CANOPY014-RS	72
BBC023	64	BBCD058	57	CANFIBRE050-SS	72	CANOPY014-SS	72
BBC024	68	BBCD059	69	CANFIBRE050-TG	72	CANOPY014-TG	72
BBC025	94	BBCD060	107	CANFIBRE050-WS	72	CANOPY014-WS	72
BBC027	54	BBCD061	61	CANFIBRE051-AB	88	CANOPY015-AB	88
BBC029	104	BBCD063	86	CANFIBRE051-DG	88	CANOPY015-BM	88
BBC031	73	BBP011	82	CANFIBRE051-SM	88	CANOPY015-DG	88
BBC033	89	BBP019E	98-101	CANFIBRE051-SW	88	CANOPY015-P	88
BBC034	108	BBP019SC	98	CANOPY001-B	89, 90	CANOPY015-SM	88
BBC038	46	BBP025	94	CANOPY001-P	89, 90	CANOPY015-SW	88
BBC039	66	BBP043	94	CANOPY001-SW	89, 90	CANOPY017-SW	88
BBC040	52	BBP056	93	CANOPY002A	89, 90	CANOPY018-B	67
BBC041	58	BBP056-VX	93	CANOPY002-P	89, 90	CANOPY018-TF	67
BBC042	76, 79	BBP062	81	CANOPY002-SW	89, 90	CANOPY019-G	51
BBC043	94	BBT002	90	CANOPY003P	77	CANOPY019-P	51
BBC044	53	BBT004	97	CANOPY003-W	77	CANOPY019-SW	51
BBC045	70	BBT005	95	CANOPY004-P	48, 68	CANOPY020-CB	57
BBC046	85	BBT006	96	CANOPY004-W	48, 68	CANOPY020-P	57
BBC047	104	BBT007	106	CANOPY005A	74	CANOPY020-SW	57
BBC048	75	BBT008	105	CANOPY006-B	54-56, 59	CAP001	42
BBC050	72	BBT011	82	CANOPY006-P	54-56, 59	DB140	23
BBC051	88	BBT012	76, 79	CANOPY006-W	54-56, 59	DB270	23
BBC055	44, 49	BBT013	78	CANOPY007-P	78	DBLOOM	23
BBC057	50, 51	BBT014	48	CANOPY008-B	73	DB MONITOR	23
BBC058	57	BBT016	74	CANOPY008-BM	73	DVD001	42
BBCD001	91	BBT018	102	CANOPY008-CG	73	DVD002	42
BBCD002	90	BBT019E	98-101	CANOPY008-IB	73	DVD003	42
BBCD003	56	BBT019SC	98	CANOPY008-P	73	DVD004	42
BBCD004	97	BBT020	55, 59	CANOPY008-S	73	DVD005	42
BBCD005	95	BBT024	68	CANOPY008-TG	73	DVD006	42
BBCD006	96	BBT025	94	CANOPY008-W	73	DVD007	42
BBCD007	106	BBT027	54	CANOPY009-P	107, 108	DVD008	42
BBCD008	105	BBT029	104	CANOPY009-W	107, 108	IALK001	23, 40
BBCD009	83	BBT031	73	CANOPY010-AB	45, 47, 67	IAWNING1.4M	27
BBCD010	43, 84	BBT033	89	CANOPY010-AM	45, 47, 67	IAWNING001 NET	27
BBCD011	82	BBT034	108	CANOPY010-BM	45, 47, 67	IAWNING001 ROOM	27
BBCD012	76, 79	BBT037	87	CANOPY010-BRACKET	45, 47, 67	IAWNING2.5M	27
BBCD013	78	BBT038	46	CANOPY010-CO	45, 47, 67	IAWNING2M	27
BBCD014	48	BBT039	66	CANOPY010-CW	45, 47, 67	IAWNING004 NET	27
BBCD016	74	BBT040	52	CANOPY010-FW	45, 47, 67	IAWNING004 ROOM	27
BBCD018	102	BBT041	58	CANOPY010-GB	45, 47, 67	IAWNING005 NET	27
BBCD020	55, 59	BBT042	76, 79	CANOPY010-IS	45, 47, 67	IAWNING005 ROOM	27

Part Number	Page	Part Number	Page
IAXE001	33	IEXHAUST006	82, 83
IAXE002	33	IEXHAUST007	44, 46
IBLOCK	17	IEXHAUST008	66
IBOOK001	42	IEXHAUST009	100
IBOTTLE001	42	IEXHAUST010	96
IBOTTLE002	42	IEXHAUST011	78
IBOW	17	IEXHAUST012	76
IBTBAGS	31	IEXHAUST013	99
IBUCKET001	29	IEXHAUST014	48, 68
IBUCKET002	29	IEXHAUST015	48, 68
IBUSHTOILET	31	IEXHAUST016	58
ICARGOBAG001	29, 37	IEXHAUST017	51, 52
ICHAIRHA004	28	IEXHAUST018	73
ICHAIRL003	28	IEXHAUST019	73
ICHAIRMS	28	IEXHAUST020	44, 46, 66
ICHAIRSA005	28	IFIRSTAID001	19
ICOMPRESSOR001	18	IFISHING001	30
ICOMPRESSOR002	18	IFISHING002	30
ICSC011F	82	IFRIDGE30	25
ICSC011R	82	IFRIDGE30 BAG	25
ICSC019F	98-101	IFRIDGE40	25
ICSC019F3/4	98-100	IFRIDGE40 BAG	25
ICSC019R	99, 101	IFRIDGE50	25
ICSC019SCF	98	IFRIDGE50 BAG	25
ICSC031F	73, 74	IFRIDGE65	25
ICSC031R	73, 74	IFRIDGE 65 74 BAG	25
ICSC033F	89, 90	IFRIDGE74	25
ICSC033R	89, 90	IFRIDGESLIDE001	25
ICSC038F	47, 67	IFRIDGESLIDE002	25
ICSC038R	47, 67	IFRIDGESTAND001	25
ICSC040F	50-53, 57, 58, 61	IFRIDGE STRAPS	25
ICSC040R	51, 52, 57, 58	IGAMMA175	20
ICSC042F	77	IGLOVES	17
ICSC042R	77	IHCLEAN	31
ICSC043F	93, 94	IHCLEANBOX	31
ICSC043R	93, 94	IHEADLAMP002	32
ICSC047F	104	IHD001	20
ICSC047R	104	IHIGHLIFT001	18
ICSC048F	75	IHIGHLIFT002	18
ICSC048R	75	IHIGHLIFT003	18
ICSC050F	72	IHIGHLIFT004	18
ICSC050R	72	IHOOK BOW	17
ICSC051F	88	IICETRAY001	29
ICSC051R	88	IKETTLE001	29
ICSC053F	92	ILANTERN001	32
ICSC053R	92	ILANTERN002	32
ICSC054F	45, 49, 67	ILANTERN003	32
ICSC054R	49	ILBSR001	22
ICSC055R	45, 67	ILBSR001C	22
ICSC059F	69	ILBSR002	22
ICSC059R	69	ILBSR002C	22
ICSC060F	107	ILBSR003	22
ICSC060R	107	ILBSR003C	22
IDBM001	23	ILBSR004	22
IDCDC40	23	ILC7AMBER	21
IDCDC5A	23	ILC7BLACK	21
IDIFFBRE	40, 43, 45, 47-75, 77-79, 81-108	ILC7BLUE	21
IDRAG	17	ILC7CLEAR	21
IDUFBAG001	29, 37	ILC9AMBER	21
IEBC001	23	ILC9BLACK	21
IEXHAUST001	98	ILC9BLUE	21
IEXHAUST002	101	ILC9CLEAR	21
IEXHAUST003	94	ILCB7AMBER	21
IEXHAUST004	104, 105	ILCB7BLACK	21
IEXHAUST005	89, 90	ILCB7BLUE	21
		ILCB7CLEAR	21
		ILED7C	20

Part Number	Page	Part Number	Page
ILED7COMBO	20	IRRCAGE22-ALLOY	34, 43, 64, 82, 83, 84, 94, 97, 100-103
ILED7SPOT	20	IRRCROSSBAR001	34
ILED9C	20	IRREXT945	34
ILED80	22	IRREXT985	34
ILED180F	22	IRREXT1085	34
ILED180S	22	IRRFEEET001	35, 50, 53
ILEDDIMMER	32	IRRFEEET100	35, 82, 83
ILEDSTRIP	32	IRRFEEET125	35, 43, 82-84, 97, 99, 101, 103, 106
ILEDWL10	22	IRRFEEET150	35
ILEDWLC	23, 32	IRRFEEET210	35, 43, 64, 84, 100, 102
ILWA001	40	IRRFEEETLC100	35, 95, 96
IMALLET	33	IRRFEEETLC200	35, 93, 94, 105
IMC001	38	IRRFEEETMUX	35, 61
IMC002	38	IRRFEEETPRADO150	35, 104
IMC003	38	IRROPEN14-ALLOY	34, 43, 64, 82-84, 99, 102, 103
IMC004	38	IRRTENT18	35, 43, 50, 53, 61, 64, 82-84, 93-97, 99-106
IMC005	38	IRRTENT22	35, 43, 64, 82-84, 94, 97, 100-103
IMCAPRIBN04	41	IRRTRADE18	35, 43, 50, 53, 61, 64, 82-84, 93-97, 99-106
IMCAPRIBN05	41	IRRTRADE18-ALLOY	34, 43, 50, 53, 61, 64, 82-84, 93-97, 99-106
IMCAPRIBN06	41	IRRTRADE22	35, 43, 64, 82-84, 94, 97, 100-103
IMCAPRIBN07	41	IRRTRADE22-ALLOY	34, 43, 64, 82-84, 94, 97, 100-103
IMCAPRIBN08	41	IRRWHEELCLAMP	35
IMCAPRIBN09	41	IRWB001	19
IMCAPRIBN10	41	ISD900	36, 65, 101, 105, 106
IMCOOPBN04	41	ISD1000	36, 43, 64, 82-84, 93-97, 103
IMCOOPBN05	41	ISD1300	36, 44, 46, 48, 51, 52, 54-59, 66, 68, 72-76, 78, 88-91, 100, 102, 107, 108
IMCOOPBN06	41	ISEAT COVER	19
IMCOOPBN07	41	ISHOVEL001	33
IMCOOPBN08	41	ISHOWER001	31
IMCOOPBN09	41	ISHOWER002	31
IMCOOPBN10	41	ISNATCH003	17
IPICNICSET001	29	ISNATCH004	17
IPOWER	30	ISNORKELO01	89, 90
IQFS001	28	ISNORKELO03	95, 96
IQFSTEP	29	ISNORKELO04	97
IQUICKGRIP001	33	ISNORKELO05	106
IRECKIT001	17	ISNORKELO06	105
IRECKIT001 BAG	17	ISNORKELO09	102
IRECKIT002	17	ISNORKELO10	94
IRECKIT002 BAG	17	ISNORKELO11	43, 84
IRLB200	37	ISNORKELO13	82
IRLB250	37	ISNORKELO15	83
IRLB350	37	ISNORKELO19	76, 79
IRLB500	37	ISNORKELO20	73, 74
IRLB600	37	ISNORKELO21	48
IROOFTENT002	27		
IROOFTENT003	27		
IROOFTENT ANNEX	27		
IROOFTENT TENT	27		
IRP019	98-101		
IRP048	75, 76		
IRP051	88, 92		
IRP200	93		
IRRCAGE14	35, 43, 64, 82-84, 97, 99-103		
IRRCAGE14-ALLOY	34, 43, 64, 82, 83, 84, 97, 99-103		
IRRCAGE18	35, 43, 50, 53, 61, 64, 82-84, 93-97, 99-106		
IRRCAGE18-ALLOY	34, 43, 50, 53, 61, 64, 82-84, 93-97, 99-106		
IRRCAGE22	35, 43, 64, 82, 83, 84, 94, 97, 100-103		

Part Number	Page	Part Number	Page
ISNORKELO22	55, 59	ITD900	36, 65, 101, 105, 106
ISNORKELO23	98-101	ITD1000	36, 43, 64, 82, 83, 84, 93-97, 103
ISNORKELO24	68	ITD1300	36, 44, 46, 48, 51, 52, 54-59, 66, 68, 72-76, 78, 88-91, 100, 102, 107, 108
ISNORKELO28	54	ITDW004	106
ISNORKELO34	44, 46	ITDW009	101
ISNORKELO34XLT	44, 46	ITDW011	82, 83
ISNORKELO35	104	ITDW013	103
ISNORKELO36	50-53	ITDW015	97
ISNORKELO37	107, 108	ITDW016	97
ISNORKELO50	72	ITDW017	96
ISNORKELO51	88	ITDW018	95, 96
ISNORKELO56	93	ITDW019	96
ISOLARMAT	30	ITDW020	93, 94
ISPEEDY	18	ITDW022	100
ISWAG001	27	ITDW023	91
ISWAG002	27	ITDW024	89, 90
ISWAGBAG	28	ITDW025	78
ITABLE001	29	ITDW026	78
ITB001	39	ITDW028	76
ITB002	39	ITDW029	76
ITB003	39	ITDW031	74
ITB004	39	ITDW032	73
ITB005	39	ITDW037	44, 46, 66
ITB006	39	ITDW038	51, 52, 57
ITB007	39	ITDW040	108
ITB008	39	ITDW048	75
ITB009	39	ITDW050	72
ITBL038	46		
ITBL039	46, 66		
ITBL040	51, 52		
ITBL041	57, 58		
ITBL048	75		
ITBL050	72		
ITBL051	88		
ITBL054	44		
ITD900	36, 65, 101, 105, 106		
ITD1000	36, 43, 64, 82, 83, 84, 93-97, 103		
ITD1300	36, 44, 46, 48, 51, 52, 54-59, 66, 68, 72-76, 78, 88-91, 100, 102, 107, 108		
ITDW004	106		
ITDW009	101		
ITDW011	82, 83		
ITDW013	103		
ITDW015	97		
ITDW016	97		
ITDW017	96		
ITDW018	95, 96		
ITDW019	96		
ITDW020	93, 94		
ITDW022	100		
ITDW023	91		
ITDW024	89, 90		
ITDW025	78		
ITDW026	78		
ITDW028	76		
ITDW029	76		
ITDW031	74		
ITDW032	73		
ITDW037	44, 46, 66		
ITDW038	51, 52, 57		
ITDW040	108		
ITDW048	75		
ITDW050	72		

Part Number	Page	Part Number	Page
ITDW051	88	LINER019	88
ITENTBAG001	27, 37	LINER020	57
ITENTFAN001	32	MINING001	40
ITENTLIGHT002	32	MINING005	40
ITOILET12	31	MINING008	40
ITOILET20	31	RSB004	52
ITOILETA+B	31	RTB038	44, 46, 66
ITORCHLEDO01	32	RTB040	51, 52
ITOW	17	RTB041	57, 58
ITREDS1100	19	RTB048	75
ITREE	17	RTB050	72
ITYRE001	18	RTB051	88
ITYRE002	18	RTBPLATE001	44, 46, 66, 88
ITYRE003	18	RTBPLATE002	51, 52, 57, 58
IUP001K	89, 90	RTBPLATE048	75
IUP002K	105	RTBPLATE050	72
IUP003F	104	SS001	54-56, 59
IUP003K	87, 104	SS004	74
IUP004E	93	SS005	91
IUP004F	94	SS007	76
IUP004K	94	SS008	48
IUP006K	78	SS009	68
IUP007E	79	SS012	82, 83
IUP007F	76	SS013	97
IUP007K	76	SS014	95
IUP008K	48, 68	SS015	101
IUP009K	54-56, 59	SS016	98
IUP010F	74	SS016SC	98
IUP010K	74	SS017	105
IUP011K	85	SS019	99
IUP012K	107, 108	SS031	73
IUP013K	70, 71	SS033	89, 90
IUP014F	44, 46, 49, 66	SS034	107, 108
IUP014K	44, 46, 49, 66	SS034 RAIL	107, 108
IUP015K	82, 83	SS039	66
IUP016K	65	SS040	52
IUP050K	72	SS041	58
IVEGA220	20	SS042	76
IWF001	25	SS044	50, 53, 61
IWINCHEXT	17	SS044 RAIL	50, 53, 61
IWING038	58	SS047	104
IWT001	40	SS048	75
IWT002	40	SS048 RAIL	75
IWT003	40	SS050	72
IWT004	40	SS050 RAIL	72
IWT005	40	SS051	88
IWT006	40	SS051 RAIL	88
IWT007	40	SS053	92
IWTHOSE	40	SS053 RAIL	92
KEY001	42	SS054	44, 46
KEY002	42	SS054 RAIL	44, 46
LINER001	90	SS055	49
LINER001-J	89, 90	SS055 RAIL	49
LINER002	77	SS056	93
LINER003	48, 68	SS056 RAIL	93
LINER004	74	SS057	51
LINER005	54-56, 59	SS057 RAIL	51
LINER006	78	SS058	57
LINER008	73	SS058 RAIL	57
LINER010	108	SS059	69
LINER011	89, 90	SSR002	48
LINER012	45, 47, 67	SSR003	76
LINER013	51, 52	SSR004	105
LINER014	58	SSR006	54-56, 59
LINER015	75	SSR007	68
LINER017	72	SSR012	82, 83
LINER018	88	SSR013	97
		SSR014	95
		SSR015	101
		SSR016	98
		SSR016SC	98
		SSR019	99
		SSR031	73, 74
		SSR033	89, 90
		SSR034	107, 108
		SSR039	66
		SSR040	52
		SSR041	58
		SSR042	76
		SSR044	50, 53, 61
		SSR047	104
		SSR048	75
		SSR050	72
		SSR051	88
		SSR053	92
		SSR054	44, 46
		SSR055	49
		SSR056	93
		SSR057	51
		SSR058	57
		SSRP011	82
		SSRP015	101

1. Interpretation

In these Terms and Conditions of Sale ("Terms"), "Goods" means the Goods the subject of the Contract; IRONMAN 4X4 Pty. Ltd. means the entity selling the Goods; "Buyer" means the entity purchasing the Goods; "Contract" means each contract between IRONMAN 4X4 Pty. Ltd. and the Buyer for the sale and purchase of the Goods and "order" includes "offer".

2. Terms and Conditions

The only Terms of the Contract are those agreed to in writing by IRONMAN 4X4 Pty. Ltd. These Terms (to the extent they are not inconsistent with Terms agreed to in writing by IRONMAN 4X4 Pty. Ltd.) and those which are implied or imposed by law (including the Trade Practices Act 1974) to the extent that it is not lawful or possible to exclude them. All other Terms, Conditions and Warranties are expressly excluded. If a conflict arises between the Terms of any order made by the Buyer and these Terms, these Terms will prevail. An agreement to deliver the Goods in instalments is taken to be a separate Contract for each instalment. These Terms and each Contract including them are governed by the laws of New South Wales, and IRONMAN 4X4 Pty. Ltd. and the Buyer submit to the jurisdiction of the courts of that State. If a Term is held to be unenforceable, the remaining Terms will apply.

3. Quotations and Orders

Any quotation made by IRONMAN 4X4 Pty. Ltd. will not be construed or operate as an offer or obligation to sell. IRONMAN 4X4 Pty. Ltd. reserves the right to accept or reject in its absolute discretion any order received by it. The Buyer will not be entitled to cancel or refuse delivery of, or payment for, any order made by it which has been accepted by IRONMAN 4X4 Pty. Ltd.

4. Price

The price payable to IRONMAN 4X4 Pty. Ltd. by the Buyer for the Goods will be the price agreed; failing which it will be the price prevailing at the date the Goods are dispatched by IRONMAN 4X4 Pty. Ltd. for delivery to the Buyer. Prices are payable in Australian currency and exclusive of delivery costs, taxes, duties and other imposts which, if changeable, are payable by the Buyer. Prices quoted in any IRONMAN 4X4 Pty. Ltd. Price List are suggested prices only and may be changed by IRONMAN 4X4 Pty. Ltd. without notice.

5. Payment

The Buyer must pay cash for the Goods on delivery or, at IRONMAN 4X4 Pty. Ltd.'s absolute discretion, strictly within 30 days of delivery. IRONMAN 4X4 Pty. Ltd. will appropriate payments first to outstanding interest and then to outstanding accounts in the date order rendered.

6. Overdue Amounts

If Buyer fails to pay all or part of any amount to IRONMAN 4X4 Pty. Ltd. when due, interest will be payable on that amount from its due date until it is paid in full at a rate equivalent to 2% per annum above the overdraft rate from time to time charged to IRONMAN 4X4 Pty. Ltd. by its principal banker.

7. Delivery

IRONMAN 4X4 Pty. Ltd. will make all reasonable efforts to deliver the Goods on the dates agreed, to the place or carrier designated by the Buyer. IRONMAN 4X4 Pty. Ltd. has the right to make delivery in instalments and to deliver those Goods available for delivery. The Buyer has no right to terminate the Contract because of a delay in delivery.

8. Warranty

IRONMAN 4X4 Pty. Ltd. warrants that its products are manufactured to S.A.E.- Society of Automotive Engineers - specifications for the particular product. IRONMAN 4X4 Pty. Ltd. further warrants that all products sold hereunder are free from defects in material and workmanship.

IRONMAN 4X4 Pty. Ltd. will, at its sole option, repair or replace any products supplied by it which are found to be defective in either materials or workmanship providing that IRONMAN 4X4 Pty. Ltd. is actually notified in

writing from the Buyer of the alleged defect within ninety (90) days from the date of invoice. Any claim not made within this period shall conclusively be deemed waived by the Buyer. Repair or replacement is preconditioned on the examination of the Goods by IRONMAN 4X4 Pty. Ltd. and, if requested by IRONMAN 4X4 Pty. Ltd. return of the Goods to IRONMAN 4X4 Pty. Ltd.

No products are to be returned to IRONMAN 4X4 Pty. Ltd. without its written consent, according to procedures outlined in this manual, and the receipt by the Buyer of specific shipping instructions. IRONMAN 4X4 Pty. Ltd. shall not be liable for any expense incurred by the Buyer in order to remedy any defect in its products. IRONMAN 4X4 Pty. Ltd. shall not be liable for any consequential, special, indirect or contingent damage, or expense arising directly or indirectly from any defect in its products or from use of any products. This warranty does not apply to (1) Goods bought for industrial, mining or agricultural use, (2) Goods bought for resupply or resale, (3) Goods no longer required by the Buyer, (4) Goods incorrectly chosen by the Buyer; or (5) Goods modified or altered by the Buyer (including changing colour).

Except as set forth herein, and except as to title, it is expressly agreed (A) that there is no warranty or merchantability or fitness for a particular purpose, nor other warranty express, implied or statutory nor any affirmation of fact, or promises by IRONMAN 4X4 Pty. Ltd. with reference to the goods which extends beyond the specifications, agreed upon by IRONMAN 4X4 Pty. Ltd. and the Buyer and (b) that the Buyer if any, mutually acknowledges that it is purchasing the goods solely on the basis of the commitments of IRONMAN 4X4 Pty. Ltd. expressly set forth herein. No person is authorised to change or add to any of IRONMAN 4X4 Pty. Ltd.'s obligations under this warranty. In no event shall IRONMAN 4X4 Pty. Ltd. be liable for anticipated profits or for incidental or consequential damages.

The Buyer agrees to indemnify and hold IRONMAN 4X4 Pty. Ltd. harmless from and against any loss, injury or damage, to person or property, that extends beyond the warranties set forth above, whether the claims against IRONMAN 4X4 Pty. Ltd. or the damages are incidental or consequential.

1 Year Warranty - Accessories / Mining Accessories / Underbody Protection

2 Year Warranty - Premium Underbody Protection

3 Year Components Warranty - Ice Cube Fridge/Freezers

3 Year 60,000km Warranty - Suspension

5 Year Warranty - Monster Winches

5 Year Compressor Warranty - Ice Cube Fridge/Freezers

IRONMAN 4X4 Pty. Ltd. warrants the original buyer, only when purchased new via authorised IRONMAN 4X4 Pty. Ltd. resellers and distributors, from date of sale.

Product is warranted against defects in material or workmanship that cause the product to perform below the specified limits set by IRONMAN 4X4 Pty. Ltd., to the extent that IRONMAN 4X4 Pty. Ltd. will repair or replace any parts which are found to be defective.

All warranty claims must be submitted via original purchasing store or chain, unless otherwise arranged.

Proof of original purchase must be presented upon request.

Products may require to be returned to IRONMAN 4X4 Pty. Ltd. for assessment or repair. Postage and removal costs involved are not the responsibility of IRONMAN 4X4 Pty. Ltd., and may only be considered upon discretion by IRONMAN 4X4 Pty. Ltd. in the event of such claim being verified.

The warranty does NOT apply where, 1) acts of neglect or misuse are evident, 2) product has been modified, 3) vehicles which are modified or not the recommended vehicle of use, 4) used in racing or competition conditions without the prior consent of IRONMAN 4X4 Pty. Ltd., 5) used beyond the expectations of the original vehicle manufacturer.

Before installation of any product, please ensure you have received the correct parts for your application.

Ordering of the correct parts is the responsibility of the Buyer. Return of a product in an unused condition will attract a 15% restock fee, where IRONMAN 4X4 Pty. Ltd. is not at fault.

Return of used or soiled product, 1) outside warranty period, 2) without fault, will result in refusal of your claim and be returned at the Buyer's expense.

Damage to products through fitment error is not covered under warranty.

9. Damage

The Buyer acknowledges that the Goods leaving IRONMAN 4X4 Pty. Ltd's premises are adequately packed. Claims for damage in transit must be made against the carrier and, while IRONMAN 4X4 Pty. Ltd. will not accept liability for any damage, details of any claim must be promptly advised to IRONMAN 4X4 Pty. Ltd. Prior to acknowledging delivery to the carrier, the Buyer must ensure that the complete consignment has been received as specified in the carrier's note. Any shortage or visible damage to outer packaging must be endorsed on the carrier's note. Any shortages and/or damages must be reported to IRONMAN 4X4 Pty. Ltd. within 72 hours or receipt.

10. Title

10.1 Title to the Goods will not pass to the Buyer until the earlier of:

(a) IRONMAN 4X4 Pty. Ltd. being paid in full under all Contracts; or

(b) the sale by the Buyer of the Goods in its ordinary course of business (in which case the Buyer must keep an accurate account of each sale, hold the proceeds of each sale separate from the Buyer's own money and pay IRONMAN 4X4 Pty. Ltd. in full from the proceeds of the purchase price of each sale, despite that the payment is not otherwise due).

10.2 Until title to the Goods passes to the Buyer, the Buyer must:

(a) hold the Goods as bailed for IRONMAN 4X4 Pty. Ltd. and keep them in good order and condition;

(b) not remove any markings placed by IRONMAN 4X4 Pty. Ltd. and ensure that the Goods can be readily identified and distinguished from other property in the Buyer's possession; and

(c) deliver the Goods to IRONMAN 4X4 Pty. Ltd. immediately upon demand and, for this purpose, IRONMAN 4X4 Pty. Ltd. is authorised to enter at any time any premises on which the Goods may be located (the costs incidental to which will be borne by the Buyer).

11. Risk

Risk in the Goods (including insurance responsibility) passes to the Buyer on delivery of the Goods to the place or carrier designated by the Buyer or, if sooner, possession of the Goods passes to the Buyer or its agent.

12. Implied Terms, Limitation of Liability and Buyers Indemnity

12.1 Subject to Clause 2, IRONMAN 4X4 Pty. Ltd's liability for any breach of a condition or warranty imposed or implied by law in respect of any Goods or services which are not of a kind ordinarily acquired for personal, domestic or household use or consumption (provided that this provision does not apply if the Buyer establishes that it is not fair or reasonable for IRONMAN 4X4 Pty. Ltd. to rely on it) will be limited to:

(a) in the case of Goods supplied, any one or more of the following (as IRONMAN 4X4 Pty. Ltd. may determine):

(i) replacement of the Goods or the supply of equivalent goods; (ii) repair of the Goods;

(iii) payment of the cost of replacing the Goods or of acquiring or obtaining equivalent goods; or

(iv) payment of the cost of having the Goods repaired; and

(b) in the case of services supplied, any one of the following (as IRONMAN 4X4 Pty. Ltd. may determine);

(i) supplying the services again; or (ii) payment of the costs of having the services supplied again.

12.2 Subject to these Terms, IRONMAN 4X4 Pty. Ltd. will not be liable for any loss, damage, expense or injury of any kind or nature suffered or incurred by the Buyer or any other person, arising out of or in connection with, the Contract (including, without limitation, liability due to negligence or wilful default of IRONMAN 4X4 Pty. Ltd. and any delay in delivery) or any error (whether negligent or not) in information supplied to the Buyer in connection with its subject matter or the use, possession or delivery of the Goods or the exercise by IRONMAN 4X4 Pty. Ltd. of its rights under Clause 16 and the Buyer will indemnify IRONMAN 4X4 Pty. Ltd. in relation to any such loss, damage, expense or injury.

13. Claims

Any claim made by the Buyer must be in writing and contain the particulars specified in the IRONMAN 4X4 Pty. Ltd's 'Application for Exchange or Credit' or 'Applications for Warranty' and be received by IRONMAN 4X4 Pty. Ltd. within 14 days after delivery of the Goods. Subject to the Contract, no claim for credit will be recognised where (1) the Goods are made to special order or the Buyer's specifications or drawings, (2) are no longer required by the Buyer, (3) are returned without the particulars required by this Clause, (4) the Buyer has modified or altered the Goods (including changing colour) or (5) if the IRONMAN 4X4 Pty. Ltd. Catalogue stipulates that return will not be accepted. If the Buyer insists on returning the Goods, it must pay IRONMAN 4X4 Pty. Ltd. a handling fee equal to 40% of the price of the Goods.

14. Force Majeure

Despite any other Term or condition of the Contract, IRONMAN 4X4 Pty. Ltd. will not be liable for any loss, damage, expense or injury of any kind or nature suffered or incurred by the Buyer or any other person, arising out of or in connection with any delay in delivery, or failure to perform any other term or condition of the Contract where that delay or failure is caused by an act of God, fire, labour dispute, civil commotion, intervention of a Government, inability to obtain labour, materials or manufacturing facilities, accidents, interruptions of or delay in transportation or any other cause beyond IRONMAN 4X4 Pty. Ltd's reasonable control

15. Errors or Omissions

IRONMAN 4X4 Pty. Ltd. has the right to correct any clerical errors or omissions, whether in computation or otherwise in any quotation, acknowledgment or document forming part of a Contract.

16. Breach by Buyer

If the Buyer breaches a Contract or IRONMAN 4X4 Pty. Ltd. is not satisfied of a Buyer's ability to pay or otherwise comply with each Contract, IRONMAN 4X4 Pty. Ltd. may by notice to the Buyer, but without compensation, terminate every Contract, suspend or cease deliveries under all Contracts, set-off all deposits against amounts due and made all amounts then outstanding by the Buyer to IRONMAN 4X4 Pty. Ltd. immediately due and payable.

17. Waiver

IRONMAN 4X4 Pty. Ltd's right under the Contract are cumulative and in addition to any other rights. No delay or failure by IRONMAN 4X4 Pty. Ltd. to enforce any right is a waiver of that right. Any waiver by IRONMAN 4X4 Pty. Ltd. of any term or breach of the Contract is not to be taken as a continuing waiver or a waiver of any subsequent breach.



MELBOURNE, AUSTRALIA

2-8 Bessemer Drive,
Dandenong South,
Victoria 3175

SAMUTPRAKARN, THAILAND

Bangna Towers - Tower A, #1708, 17th Floor
2/3 Moo 14 Bangna Trad Road, Km 6.5
Bangkaew, Bangplee
Samutprakarn 10540

To contact Ironman 4x4 call +613 9532 1111 or visit us at:



www.ironman4x4.com



Find us on Facebook
facebook.com/Ironman4x4au

VOLUME 10

250817

INTERNATIONAL